

Underpacking Flim

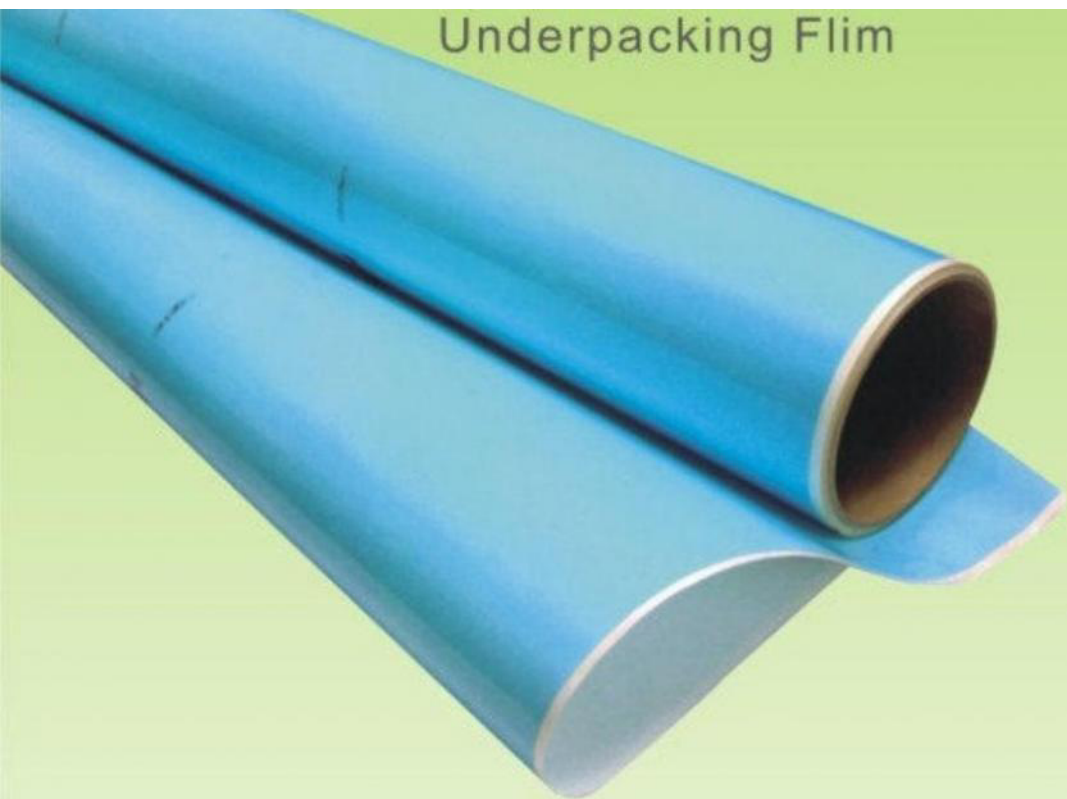

炮底胶用于印刷机印版滚筒衬垫，厚度精确均匀
黏贴在背面，防止印刷时滑动
可移性黏胶、拆装方便，不残留黏胶在滚筒上，
聚脂材质，经久耐用。

Thickness厚度(mm)

0.10、0.12、0.14、0.16、0.20、0.23

0.25、0.30、0.35、0.40、0.45、0.50

Sheet Size 单张规格(mm)

1030X760 1450X1150

Anti Marking Flim



防脏砂纸

Anti Marking Paper

HB-1



HB-2

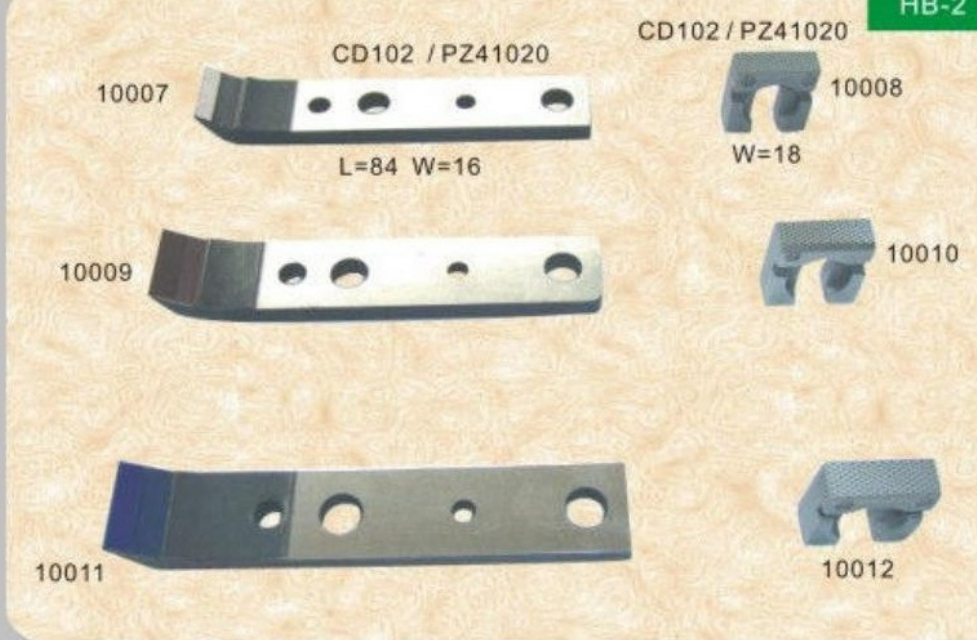

HB-3

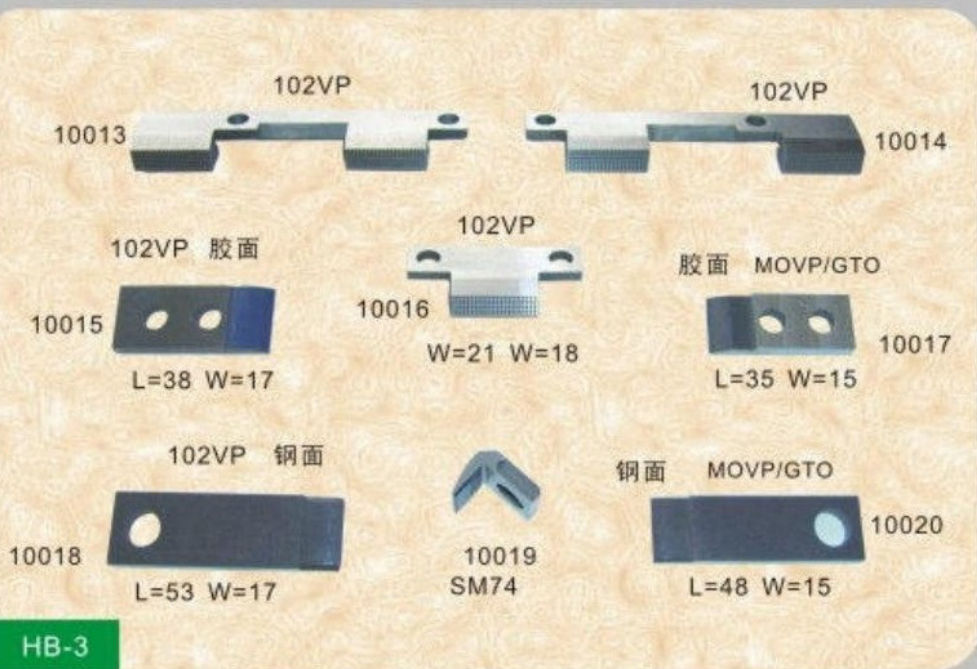

HB-4



HB-5

10025
L=74
W=18
SOR

10026
L=76
W=18
KSB/KORD

10027
102V/SOR/MO
PZ4650 / PZ41020
铆丝 M4X8

10028
MO / PZ4650

HB-6

10029
GTO
KSB
KORD
O型孔

10030
GTO

10031
GTO

10032
MO
PZ4650

10033
多种规格
CD102

10034
10035
GTOVP / MOVP

10036
W=22

10037
KSB
KORD
L=76
W=18

10038
102VP
L=73
W=16

10039
SM74

10040

10041
KSB
KORD
L=76
W=18
胶面

10042
L=67
W=14
胶面

10043
L=67
W=14
喷沙

10044
SM74

10045

HB-7

10046
A
B

10047A
10047B

10048
10049

10050
GTO

10051
光面
长两种

10052
MO
PZ4650
条纹

10053
W=18
CD102
条纹

10054
W=18

10055
W=15

10056
W=13

10057

HB-8

HB-9

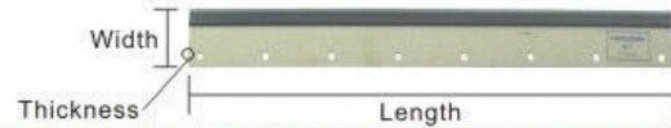
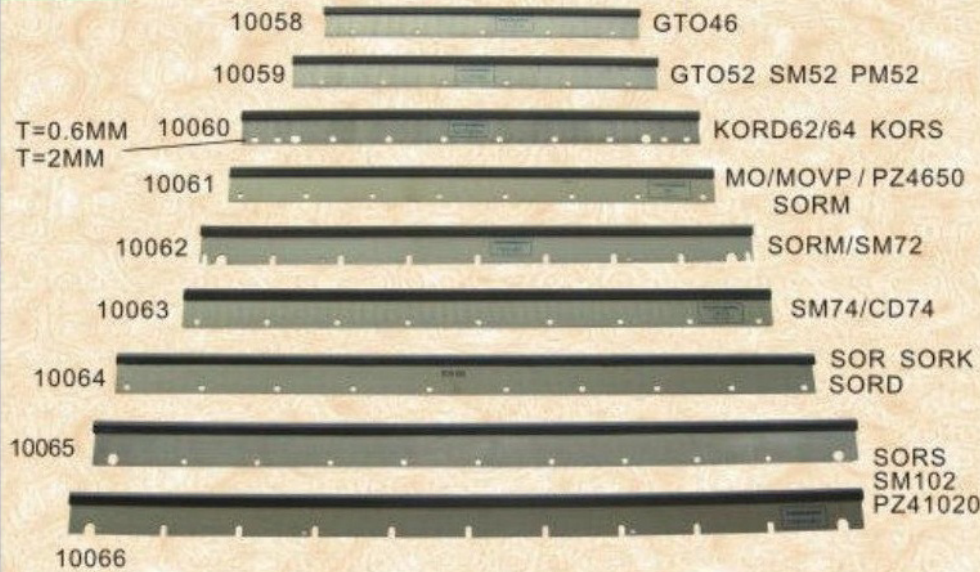

NO	MODEL	Length	Width	Thk	No Holes	NO	MODEL	Length	Width	Thk	No Holes
01	TOK	283	43	3.0	4	29	KOR	600	50	2.0	10
02	TOK	283	43	0.5	4	30	KORA	622	50	2.0	10
03	Quickmaster	375	43	3.0	5	31	KORD 62	650	50	2.0	10
04	GTO46	500	60	0.5	5	32	KORD 64	690	50	2.0	12
05	GTO46	448	40	6.0	3	33	KORS	760	50	2.0	12
06	GTO52	560	60	0.5	6	34	SOR	890	50	2.0	10
07	GTO52	508	40	6.0	3	35	SOR Z	890	51	2.0	9
08	MO	710	60	0.5	8	36	SORD	960	60	0.5	10
09	MO	692	60	0.5	7	37	SORD	960	50	2.0	12
10	MO	710	60	2.0	8	38	SORK	710	60	0.5	8
11	MO	720	60	0.5	8	39	SORK	721	50	2.0	12
12	MO	648	52	6.0	3	40	SORM	790	60	0.5	11
13	Speedmaster 52	605	46	0.5	7	41	SORM	790	50	2.0	12
14	Speedmaster 72	790	60	0.5	11	42	SORM Z	753	42	0.5	9
15	Speedmaster 72 VP	753	40	0.5	9	43	SORM Z	790	60	0.5	11
16	Speedmaster 72	790	60	0.5	11	44	SORS	1090	60	0.5	11
17	Speedmaster 72	742	57	0.5	8	45	8 Page Web	570	51	2.0	8
18	Speedmaster 74	820	57	0.5	9	46	16 Page Web	1036	51	2.0	12
19	Speedmaster 102	1090	60	0.5	11	47	PLATEN 10x15	390	51	6.0	5
20	Speedmaster 102	1090	60	3.0	11	48	PLATEN 13x18	470	51	6.0	6
21	Speedmaster 102	1090	60	5.0	11	49	KS	530	45.6	1.0	8
22	Speedmaster 102	1090	60	0.5	11	50	KSBA & KSBA	572	45.6	1.0	8
23	Speedmaster 102	1042	60	0.5	11	51	KSD	648	48	1.0	8
24	Speedmaster 102	1042	57	0.5	11	52	OHZ	720	45.6	1.0	10
25	Speedmaster 102	1042	57	5.0	11	53	SB & SBG	770	45.6	1.0	10
26	Speedmaster 102 CD	1090	60	0.5	11	54	SBB	810	45.6	1.0	10
27	Speedmaster 102 VP	1052	40	0.5	11	55	SBG Group 11	835	50	1.0	8
28	Rotaspeed	1050	60	0.5	11	56	SBD	884	45.6	1.0	10

HB-10



HB-11



HB-12



HB-13



HB-14

HB-15

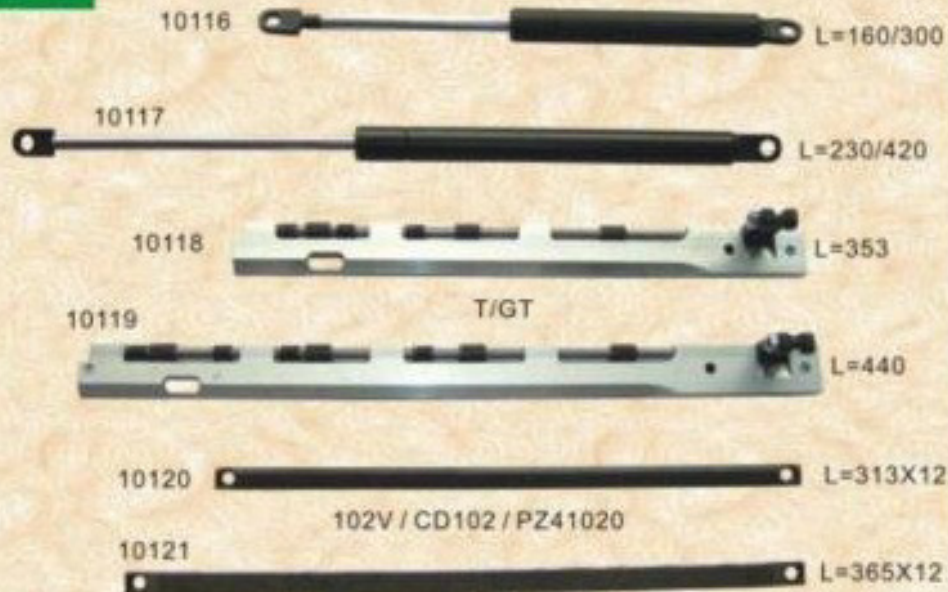

HB-16

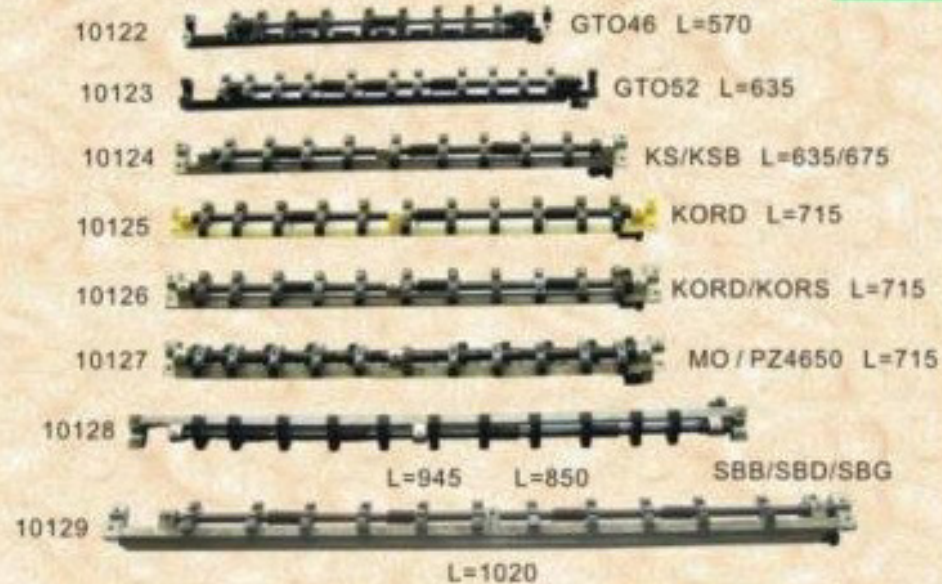

HB-17

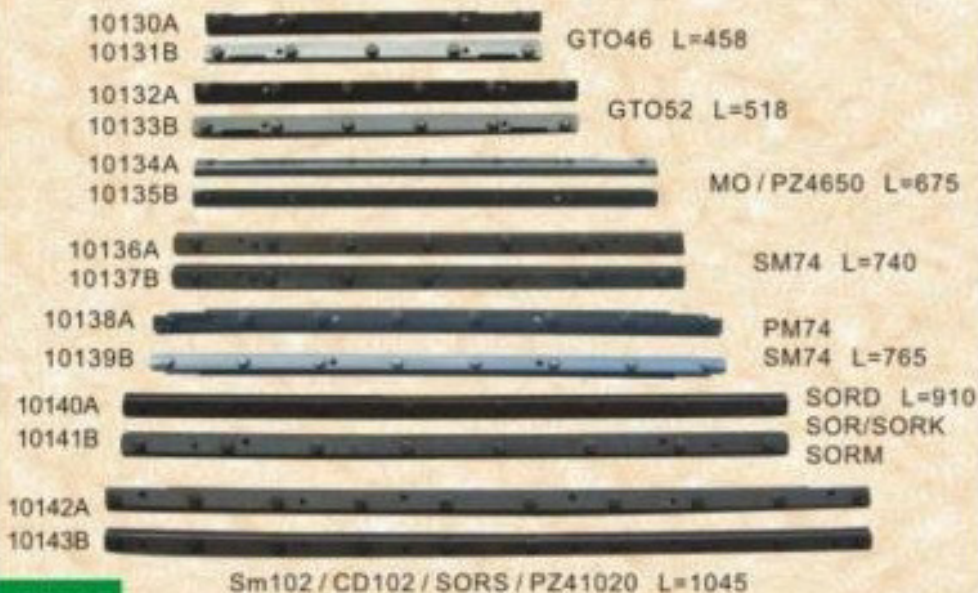

HB-18

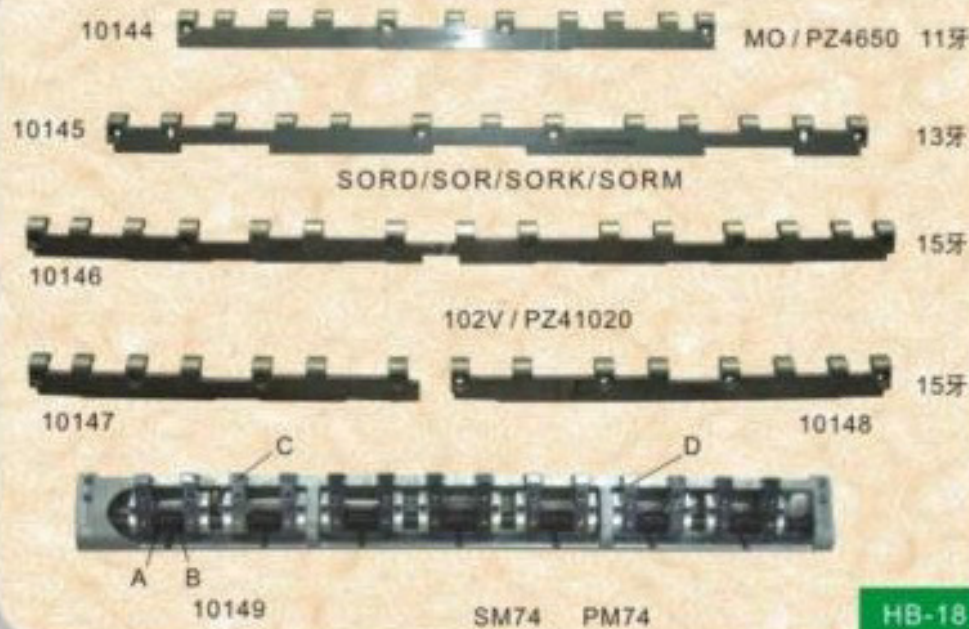

HB-19

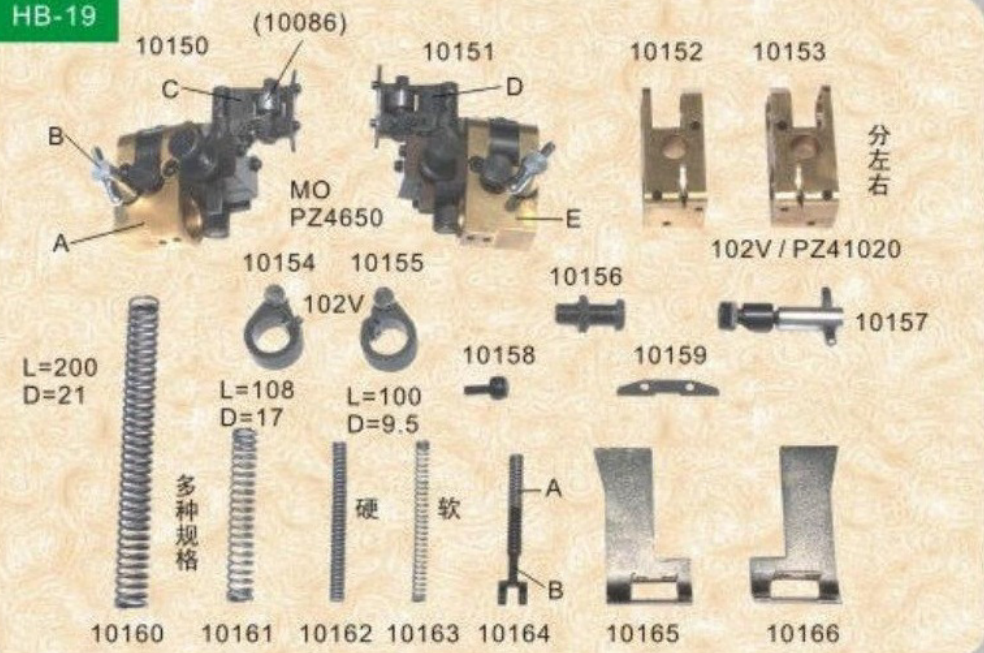

HB-20

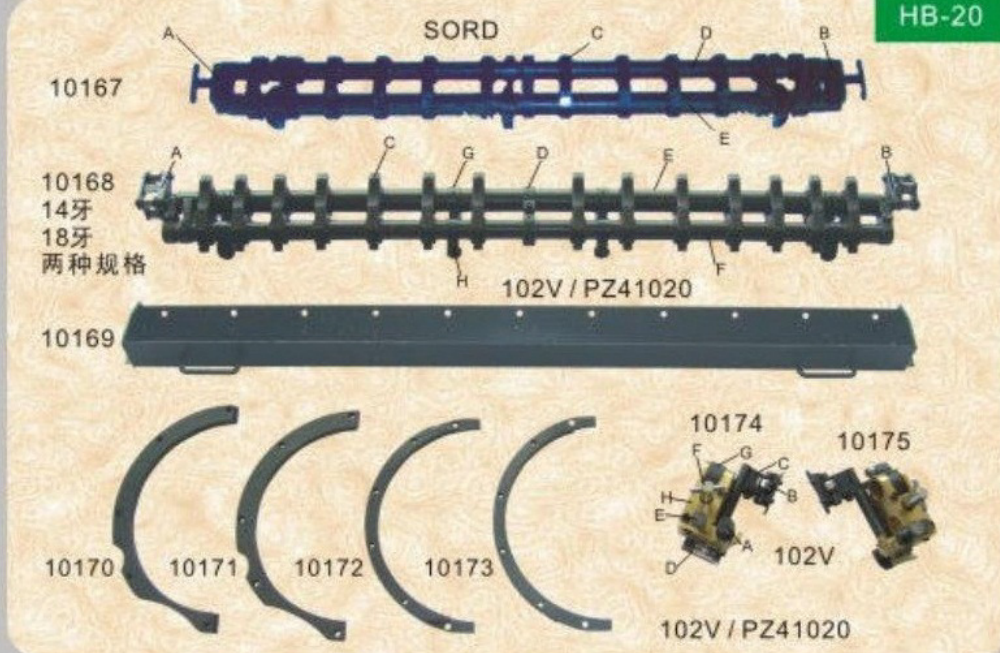

CD102 配10181

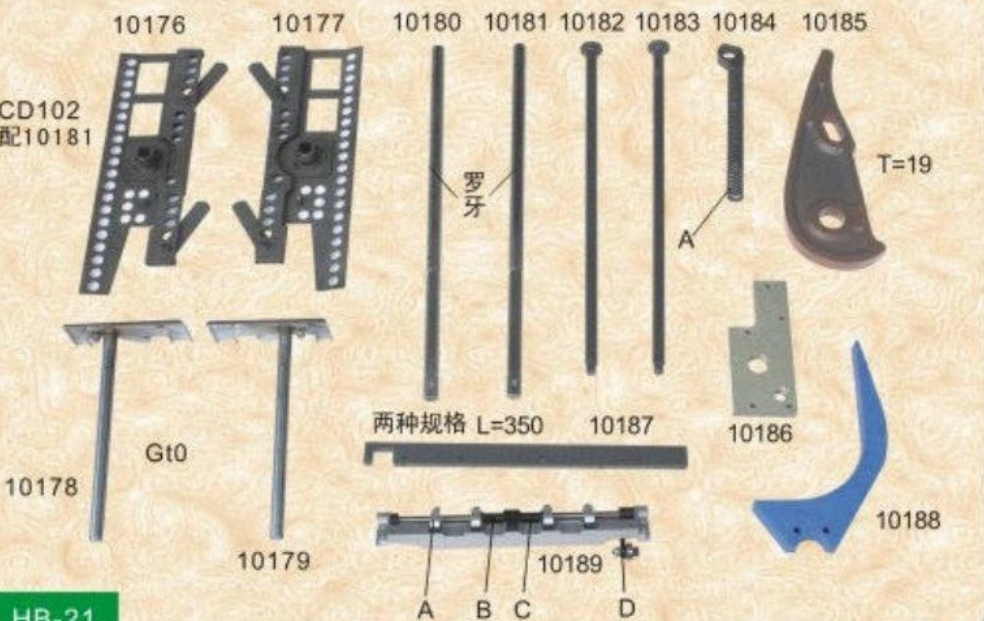

HB-21



HB-22

HB-27

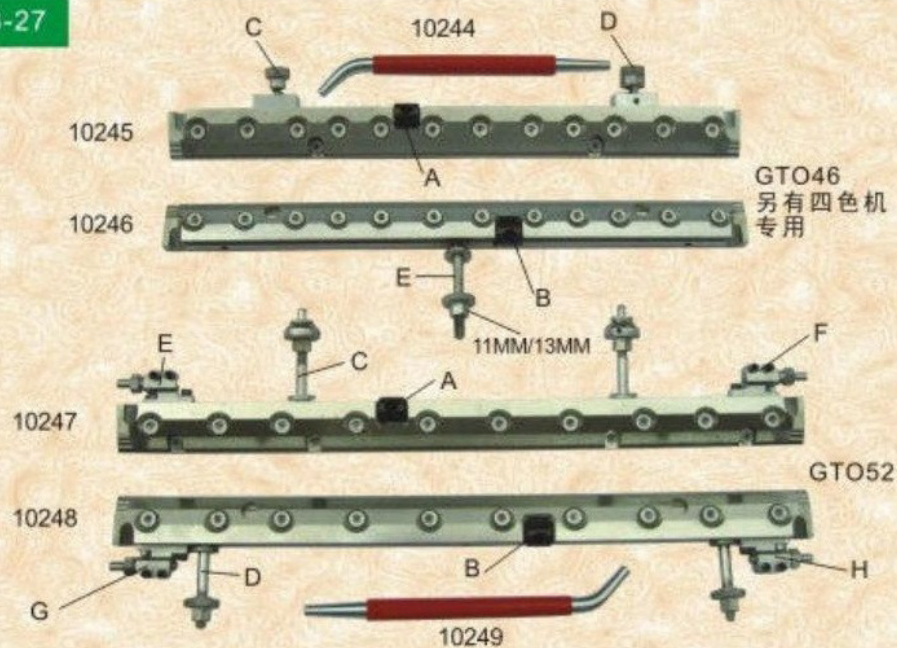

HB-28

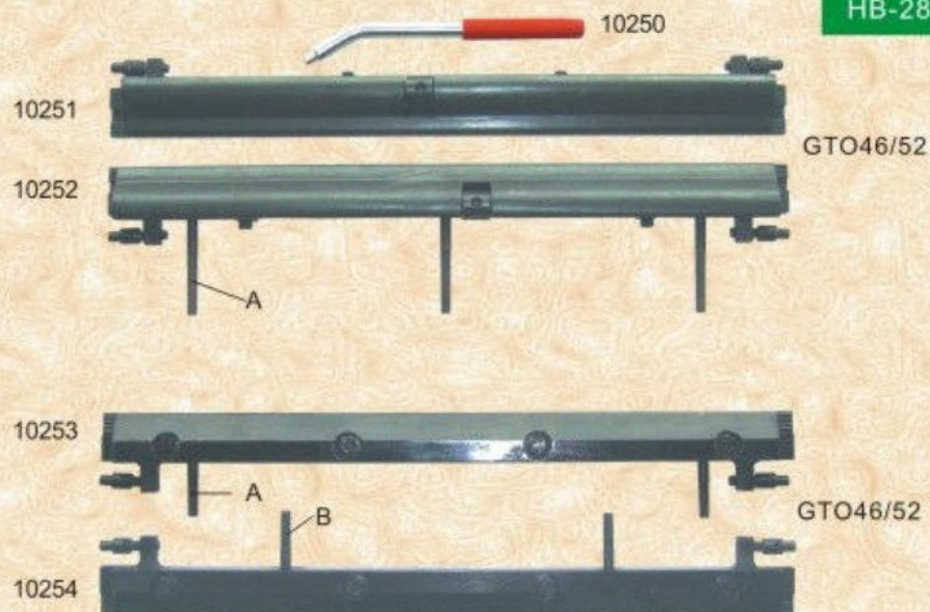

HB-29

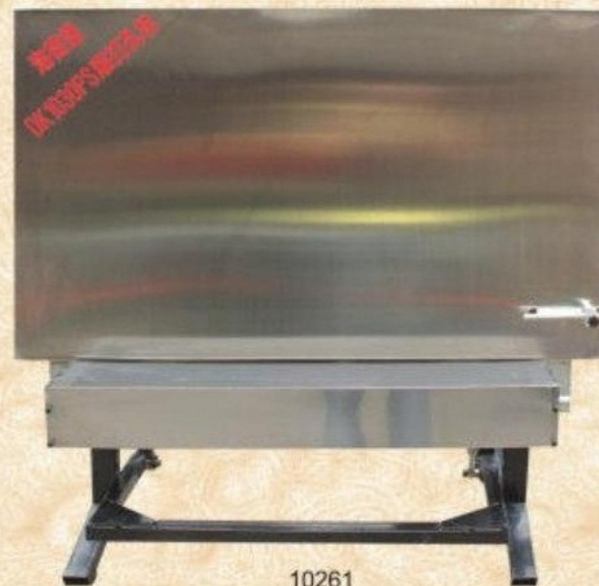
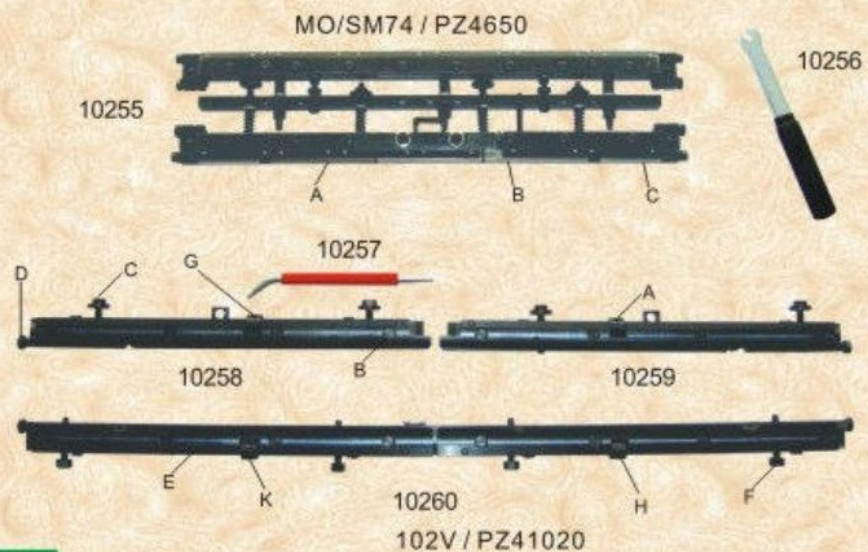

八开
四开
对开
打孔机

HB-30

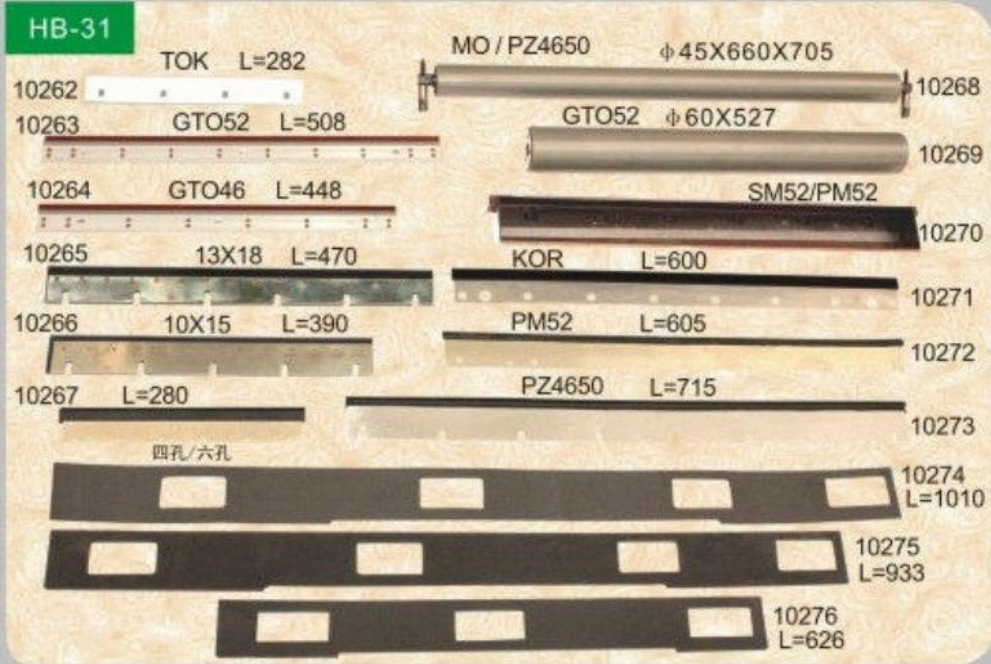

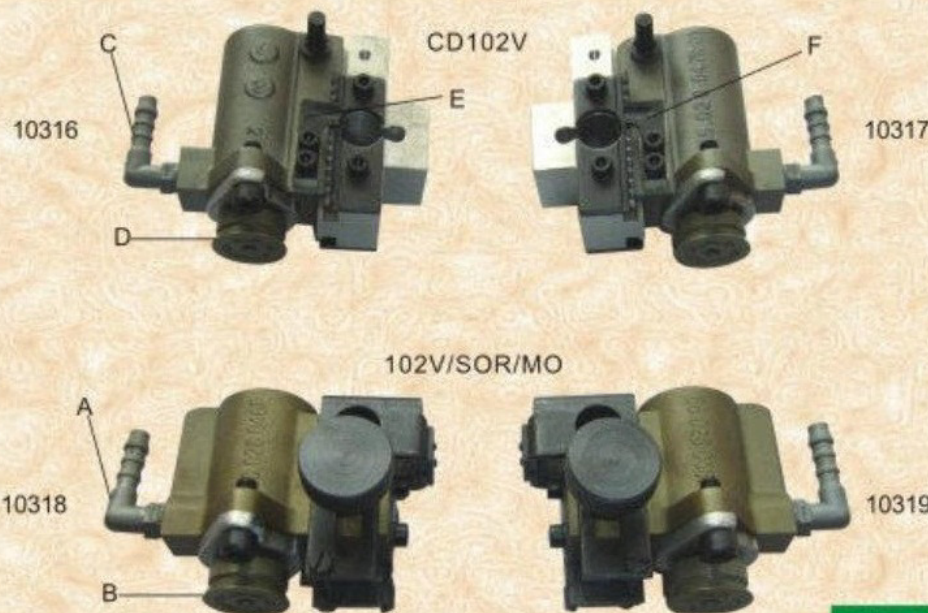
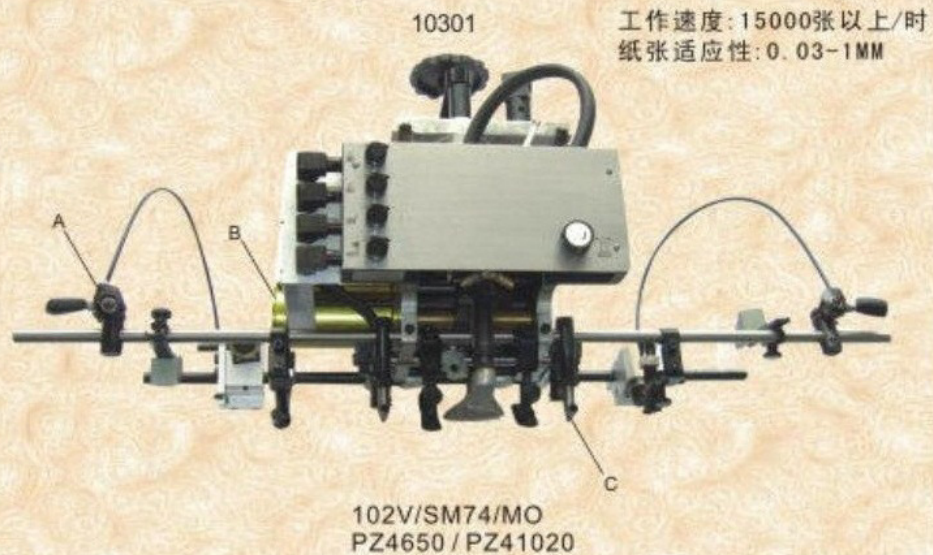

HB-39



HB-40

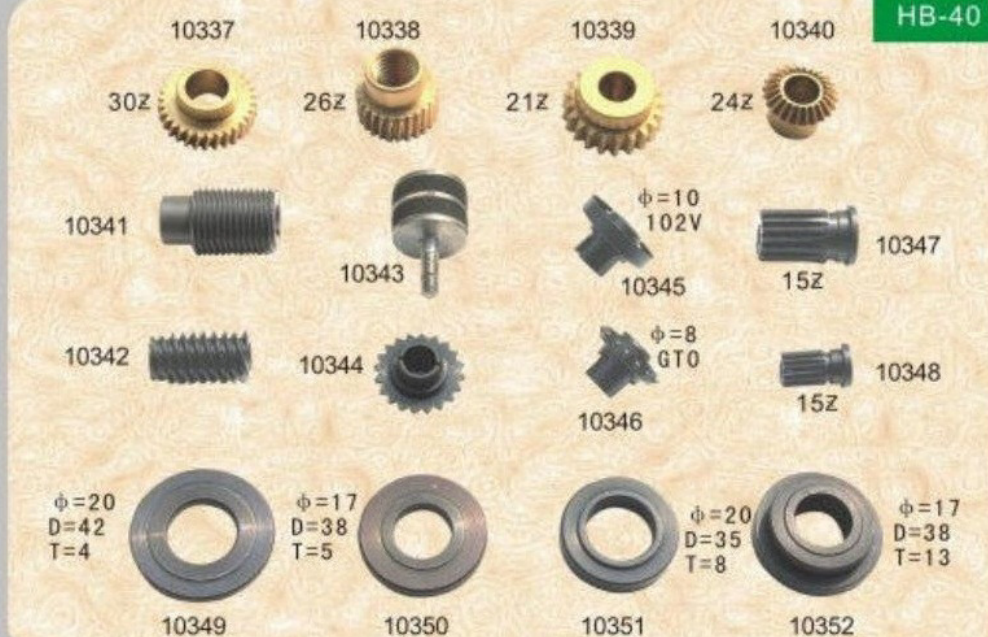

10353



10354

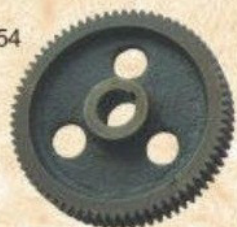

10355



两款



10356

102V / PZ41020

10357



10358



配10543 配10626 28齿14孔

102V / PZ41020 / SORD 多种规格

HB-41

10361

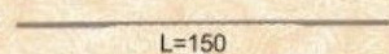

10362

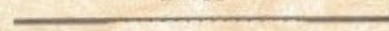

10363



10364

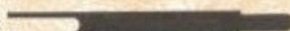

10365



SM52



10367



$\phi=7$ D=39



$\phi=4$ D=30



10373



10374



$\phi=6$ D=35



$\phi=12$



10369 L=61



L=65



$\phi=17$ D=38 T=9



$\phi=17$ D=38 T=15



10375

10376

10376

10376

10376

10376

10376

10376

10376

10376

10376

10376

10376

10376

10376

10376

10376

HB-42

HB-43



HB-44



HB-45



HB-46



HB-47



HB-48



HB-49

HB-50

HB-51



HB-52



HB-53



HB-54

HB-55



HB-56

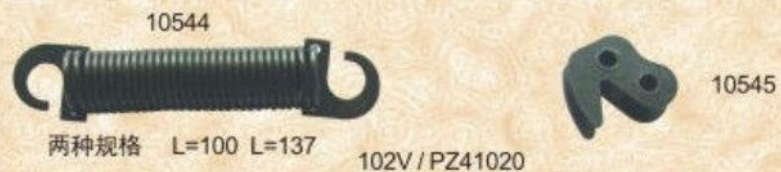

HB-57

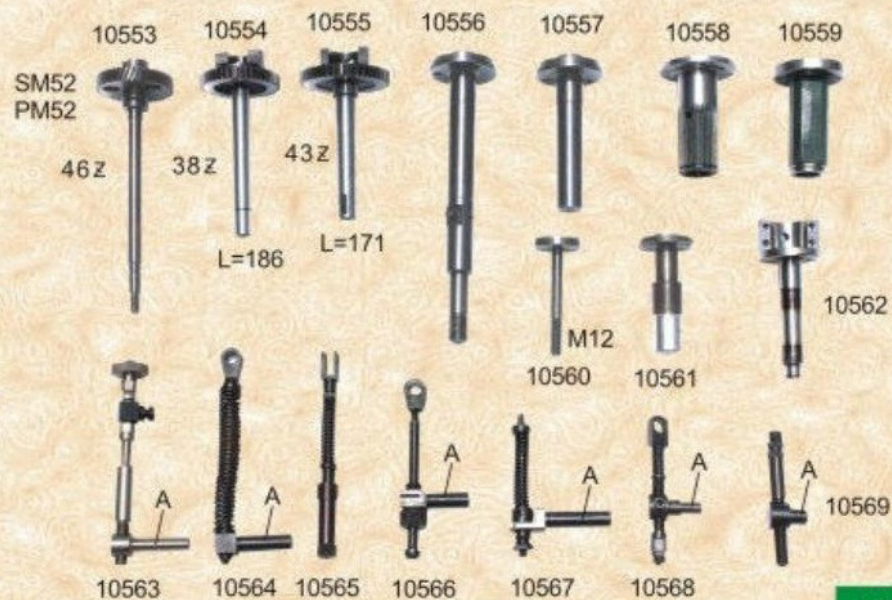

HB-58

HB-59



HB-60



HB-61

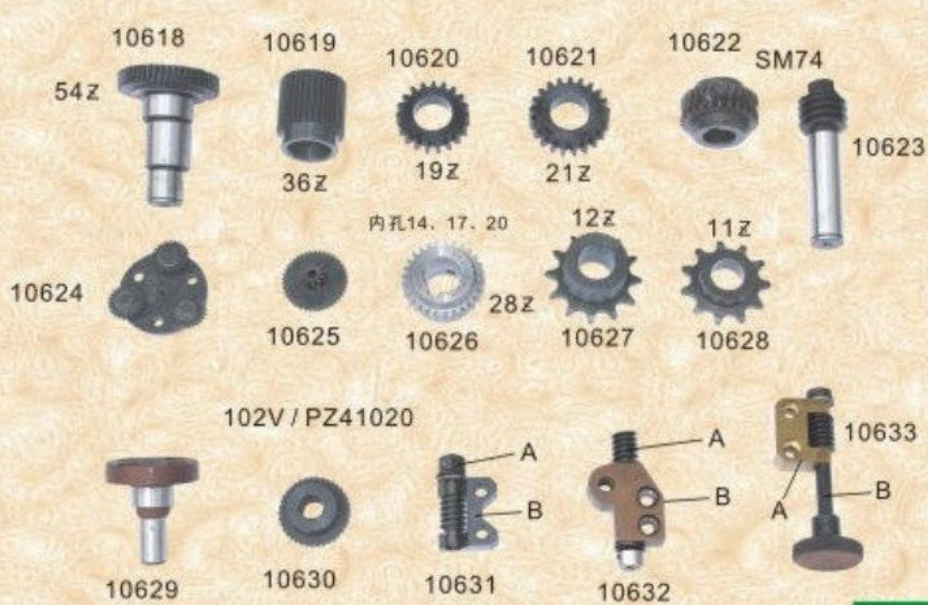

HB-62

HB-63

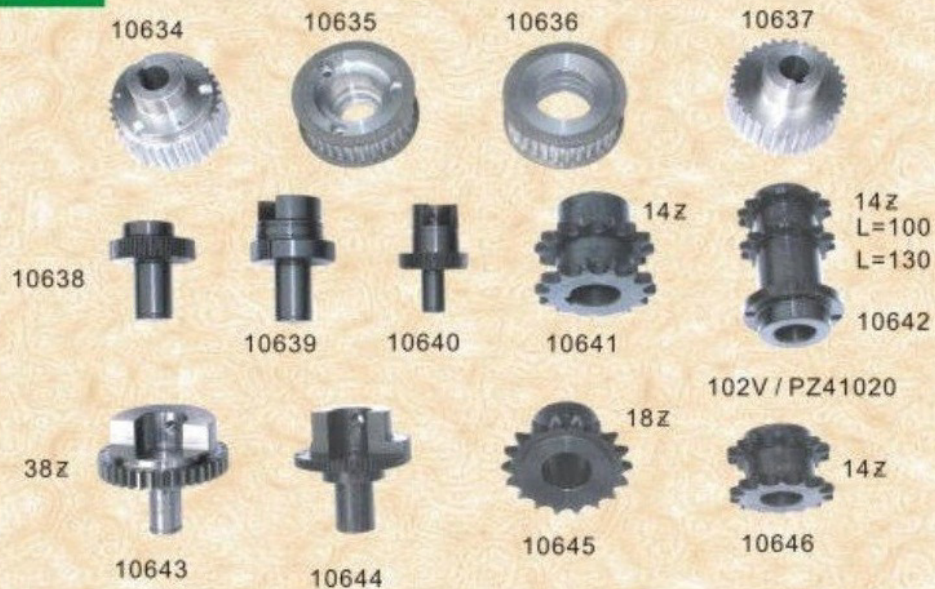

HB-64



HB-65



HB-66

HB-67

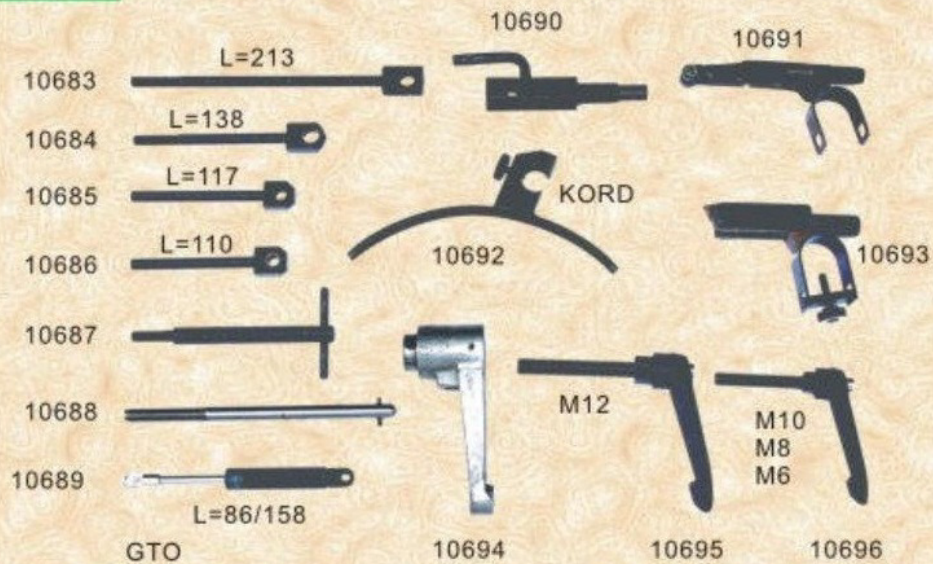

HB-68



HB-69



HB-70

HB-71



HB-72



HB-73

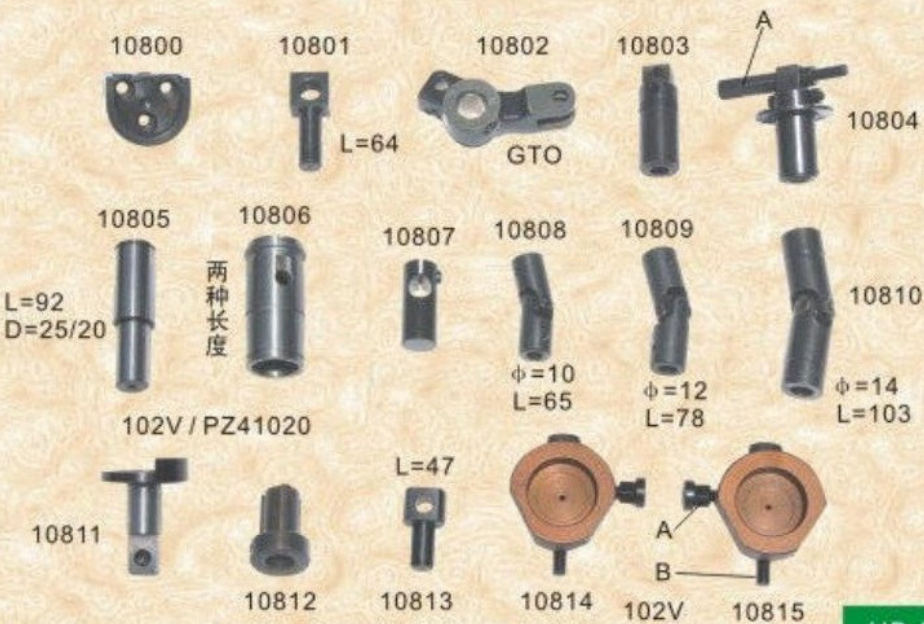

HB-74

HB-75

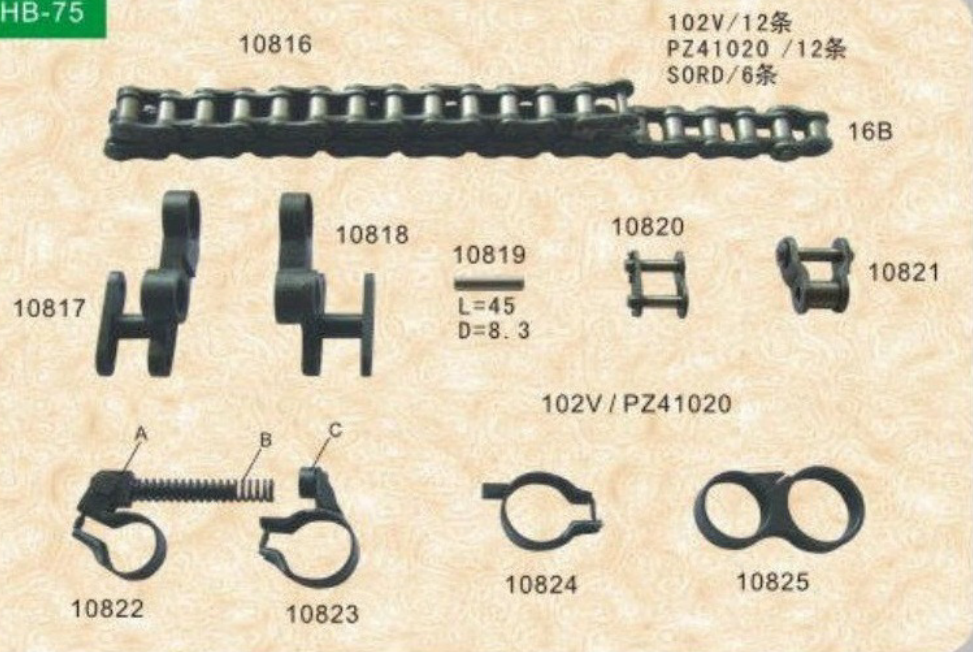

HB-76



HB-77



HB-78



HB-79



HB-80

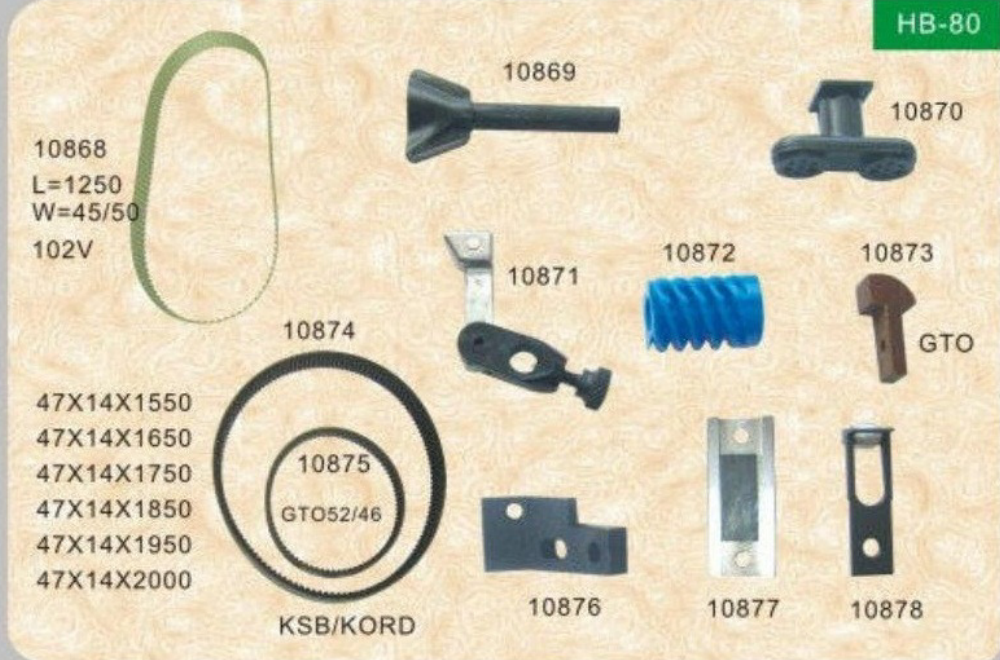

HB-81

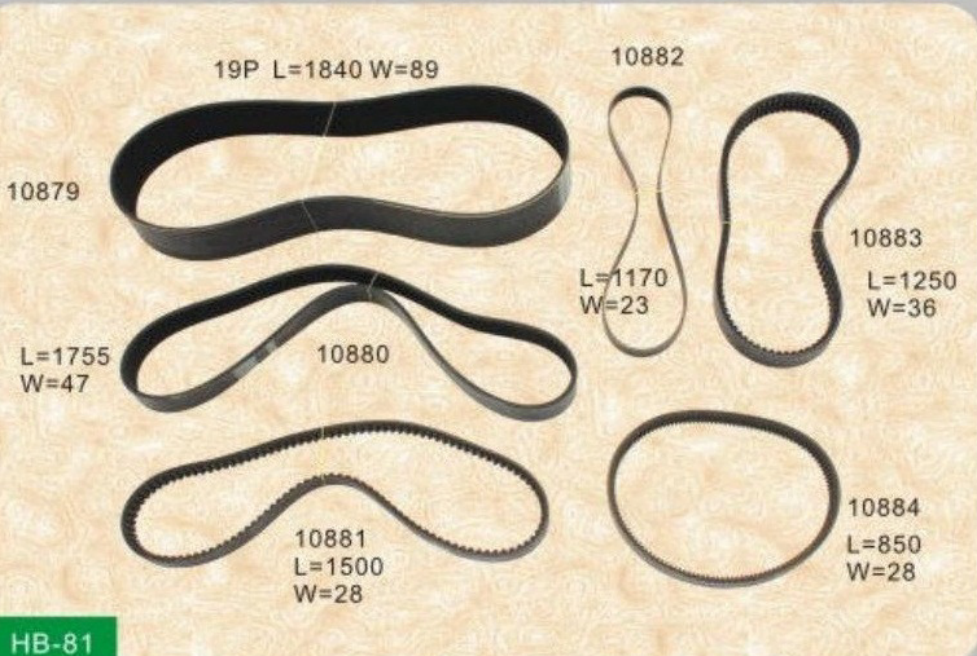

HB-82



HB-83

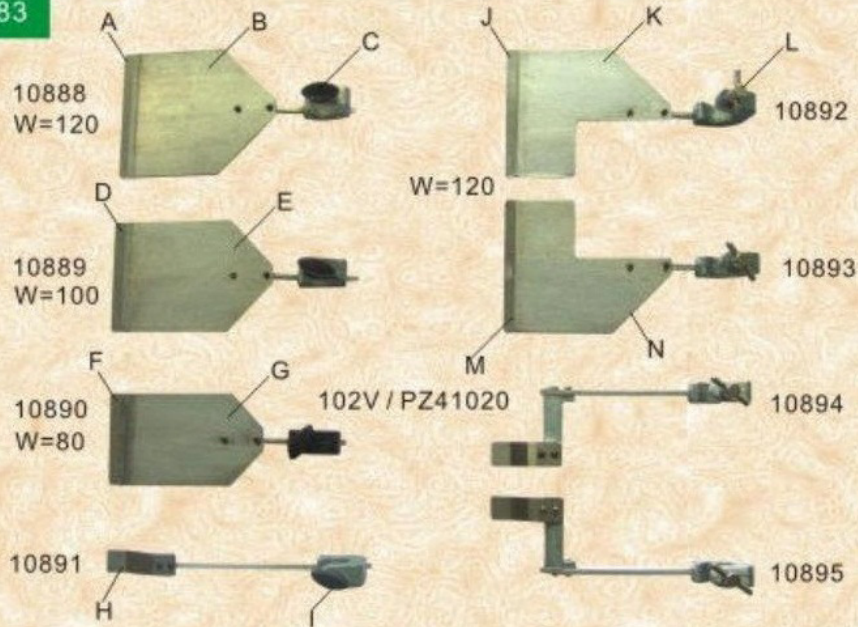

HB-84

GTO, MO, SM74, PZ4650, PZ4740
102V / PZ41020



HB-85



HB-86

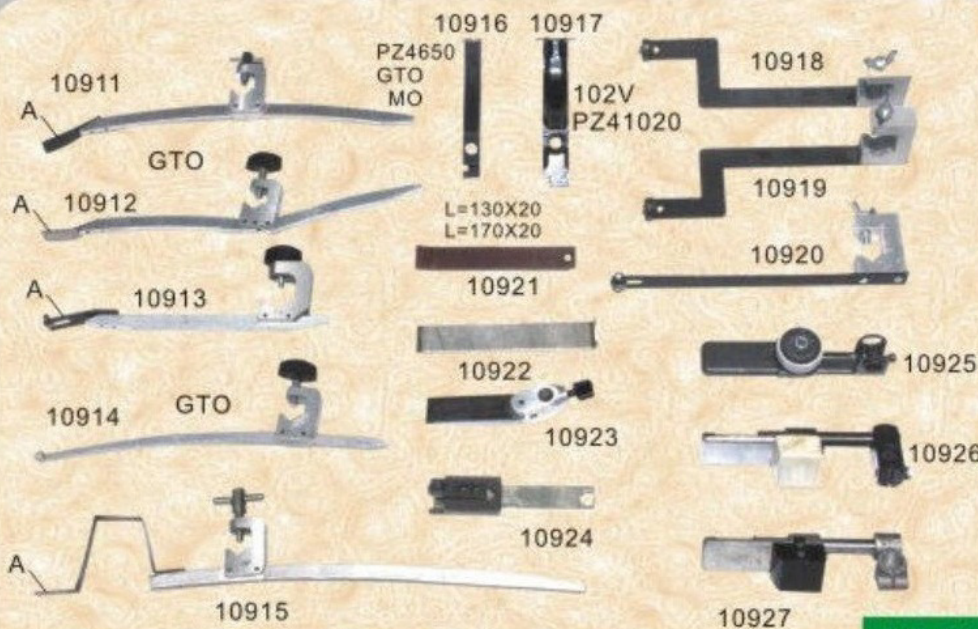

HB-87

$\phi=8$
T=20
D=55/60

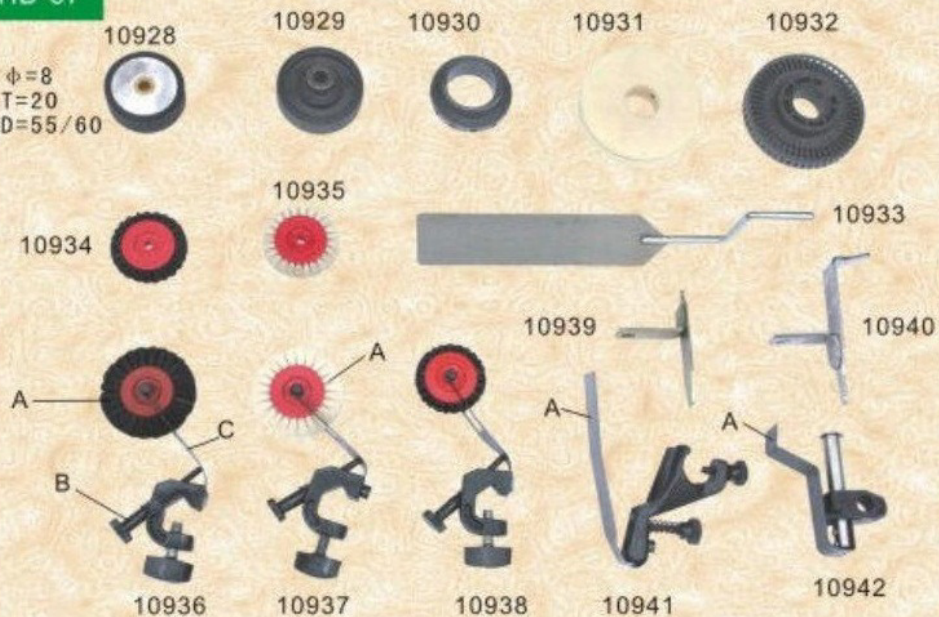

HB-88

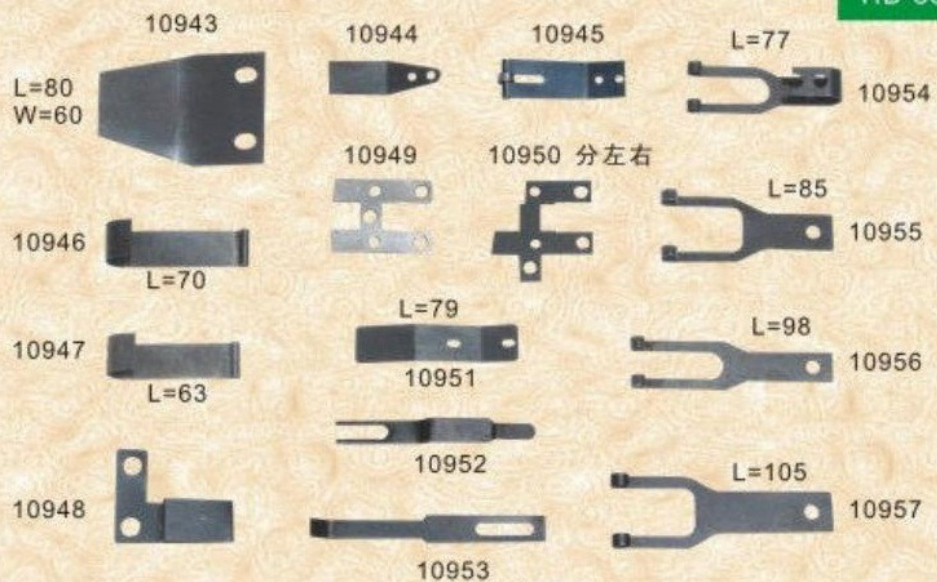

HB-89

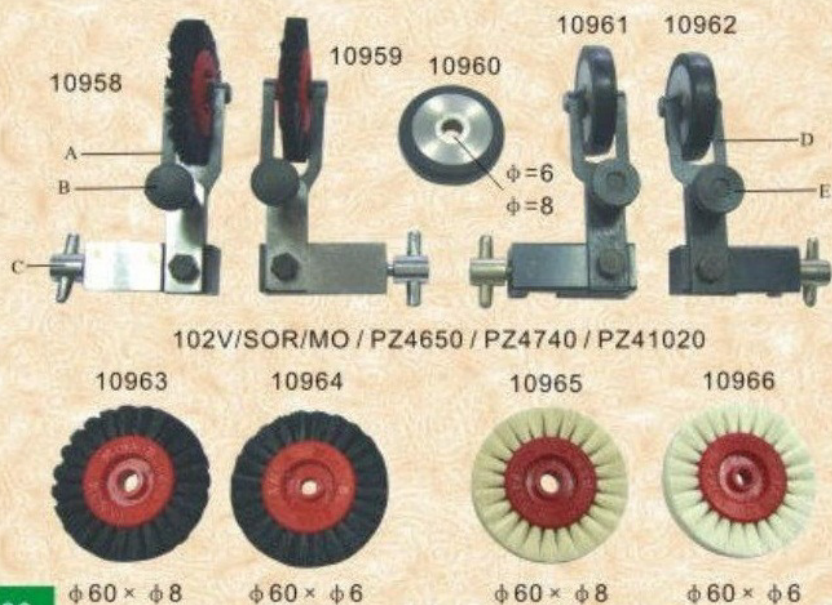

HB-90

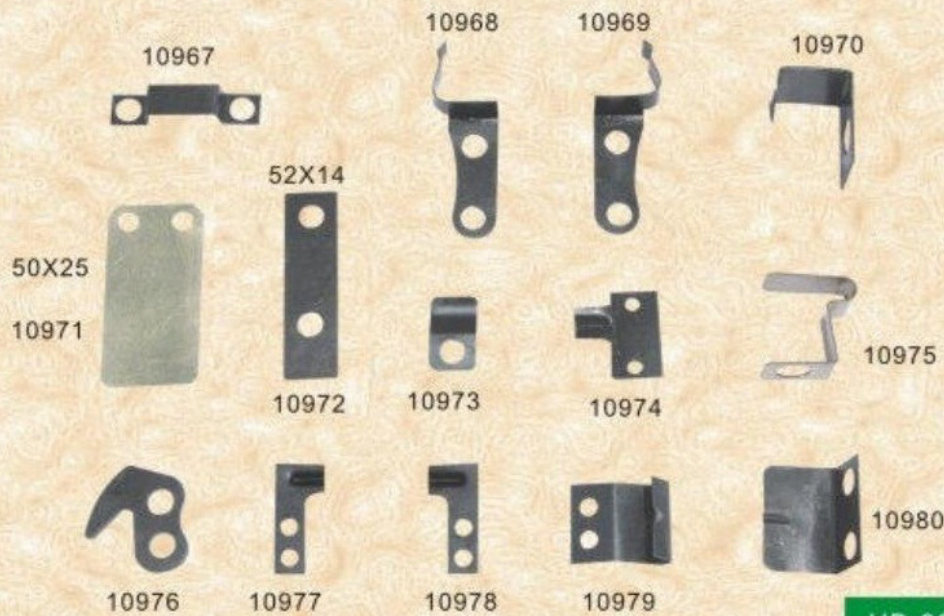

HB-91



HB-92

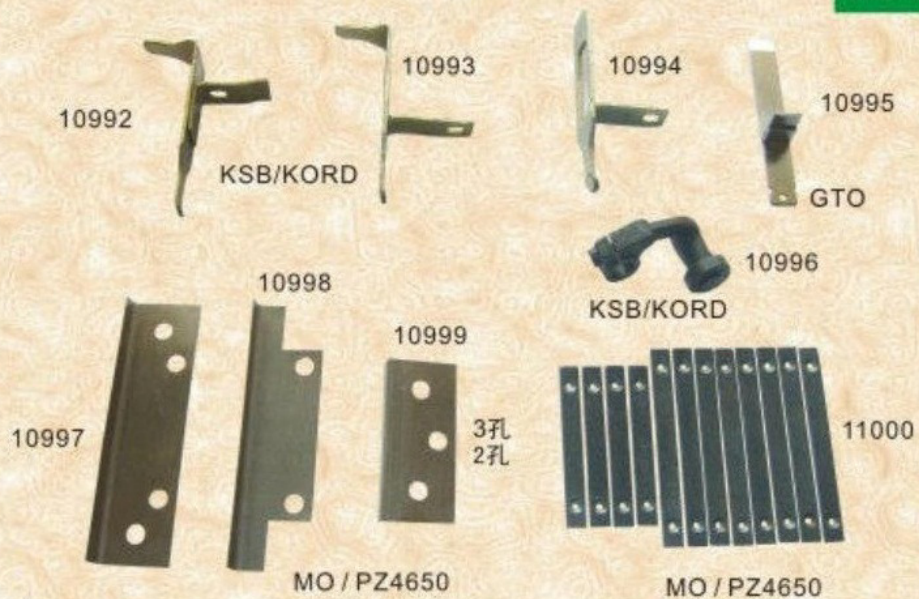

HB-93

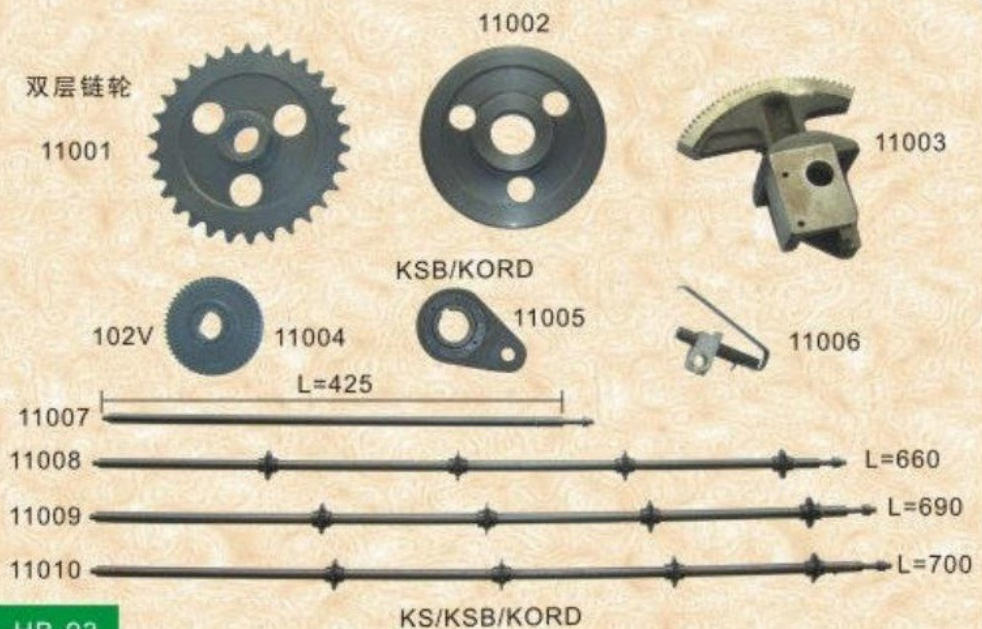

HB-93

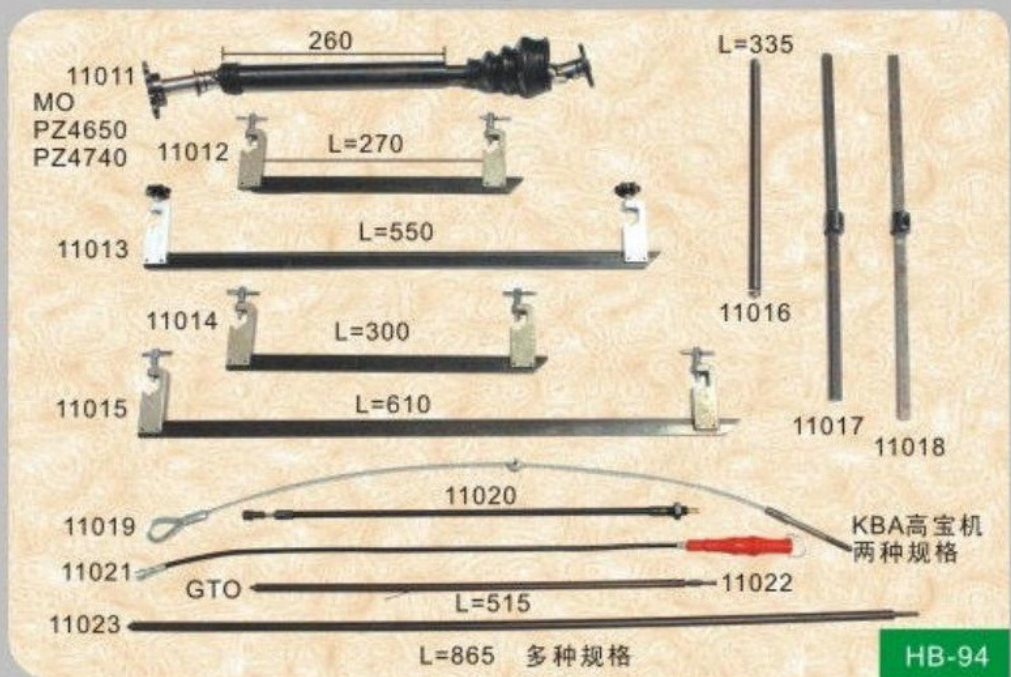

HB-94

HB-95

MO, SM74, 102V, PZ4740, PZ41020

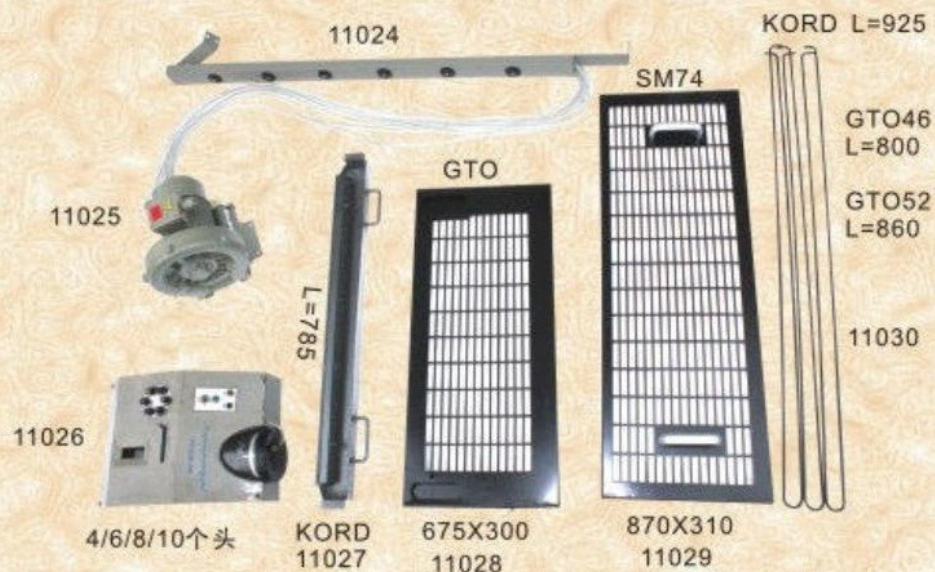

HB-96



传纸滚筒、压印滚筒、砂面、光面包衬钢皮

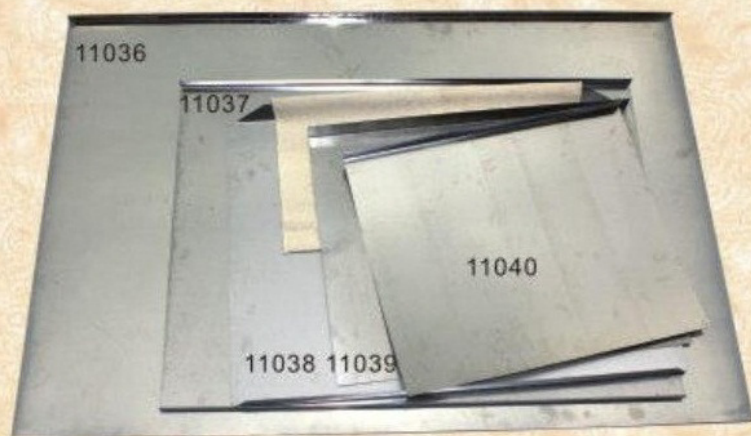

GTO46, GTO52, SM52, PM52, MO, KORD, SM74, SM102, PZ4650, PZ4740, PZ41020

HB-97

NO.	MODEL	METAL THICKNESS	SIZE(cm) WIDTH	SIZE(cm) LENGTH
1	PRINTMASTER 46	0.3	36	46
2	PRINTMASTER 52	0.3	36	52
3	GTO 46	0.3	32	46
4	GTO 52	0.3	36	52
5	SM 52	0.3	36	52
6	MO65	0.3	48	65
7	SM72	0.3	52	72
8	SM74	0.3	52	74
9	SM102	0.3	72	102
10	KOR	0.6	40	57
11	KORA 57	0.6	46	57
12	KORD 62	0.6	46	62
13	KORD 64	0.6	46	64
14	KORS 72	0.6	52	72
15	KS	0.6	38	52
16	KSB	0.6	40	57
17	KSBA	0.6	46	58.5
18	KSBAZ	0.6	46	57
19	KSD	0.6	46	64
20	S(OHZ)	0.6	54	72
21	SB-SBG	0.6	56	77
22	SBG	0.6	54	77
23	SBB	0.6	57	82
24	SBD	0.6	64	90
25	SBD(SPECIAL)	0.6	64	89

HB-98

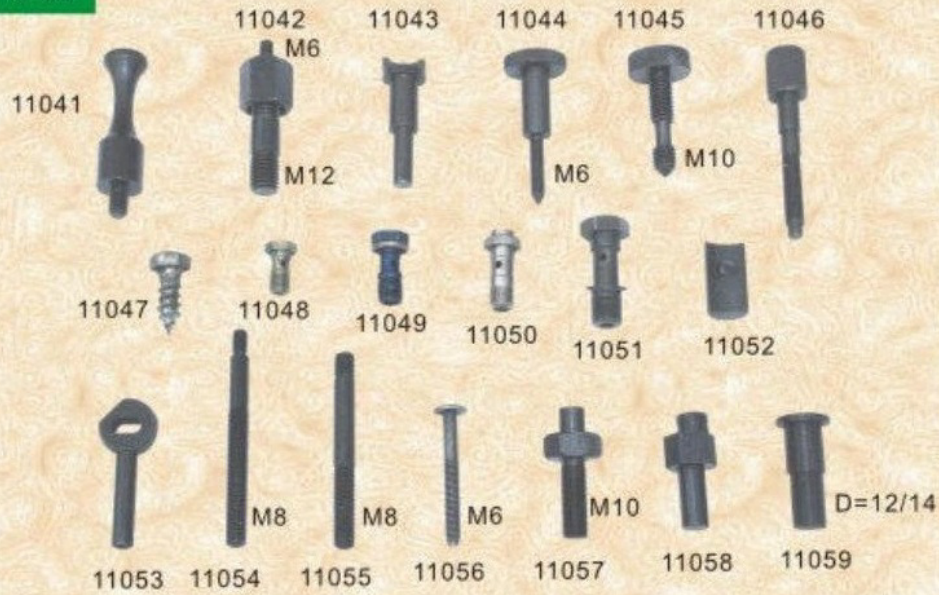

HB-99

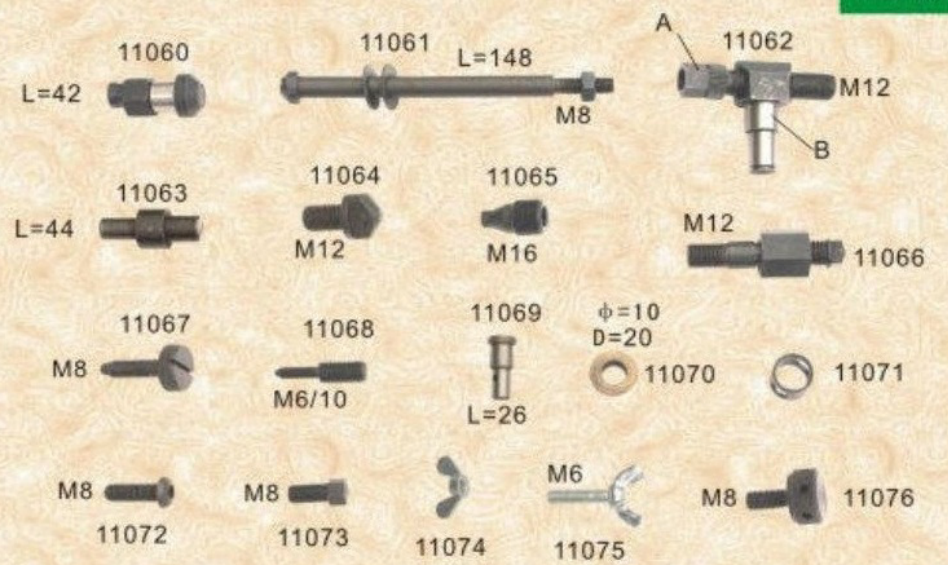

HB-100



HB-101



HB-102



HB-103



HB-104

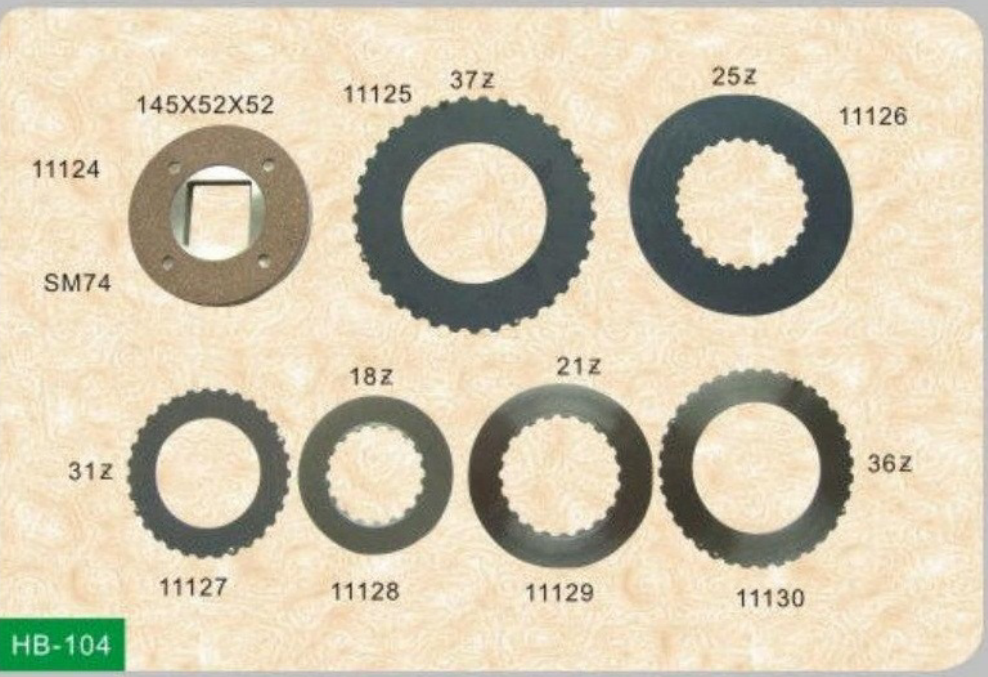

HB-105



HB-106



HB-107



HB-108



HB-109

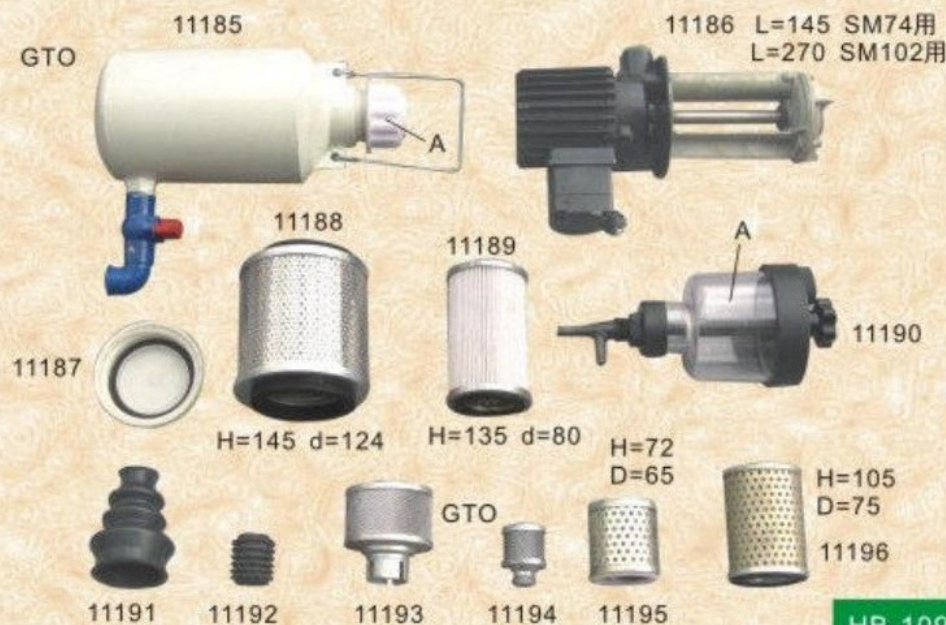

HB-110



HB-111

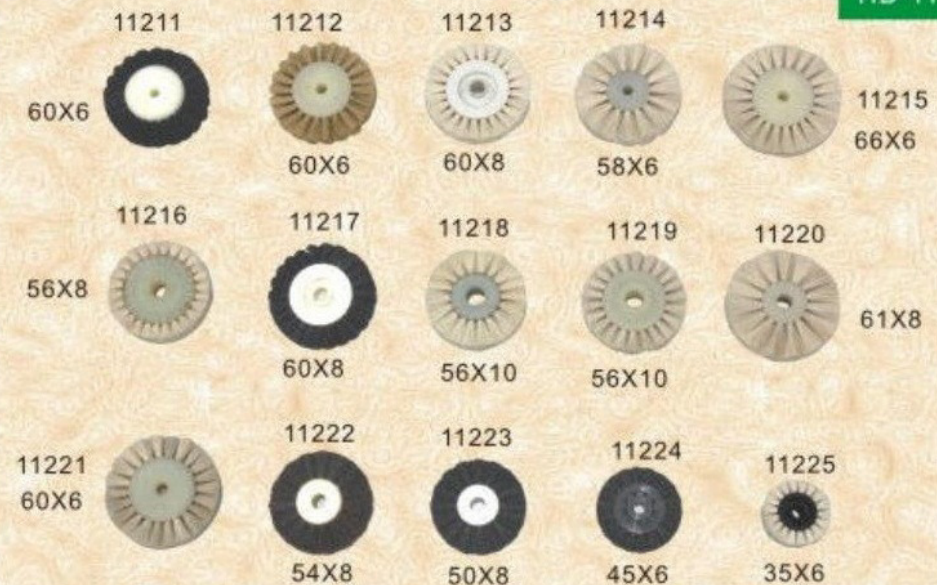

HB-112

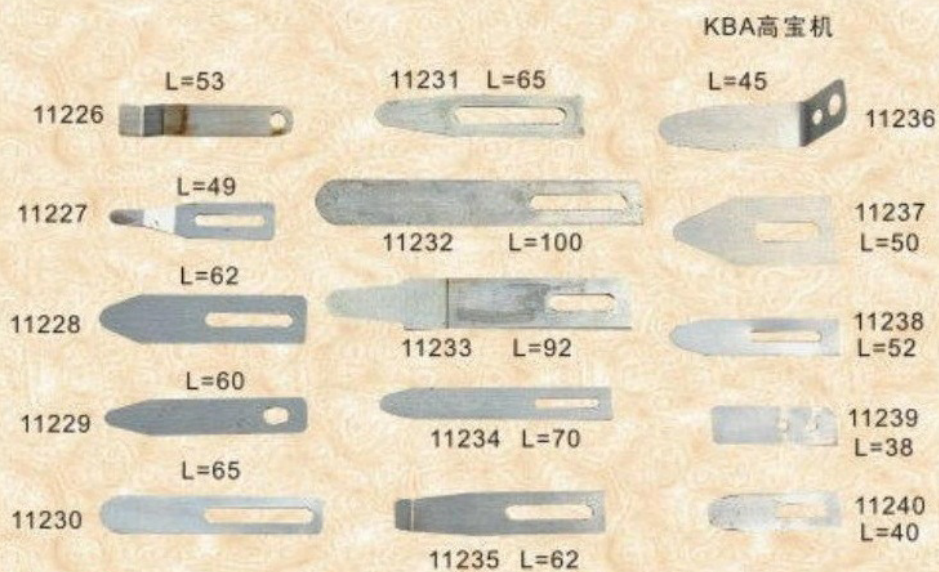

HB-113



HB-114



HB-115



HB-116

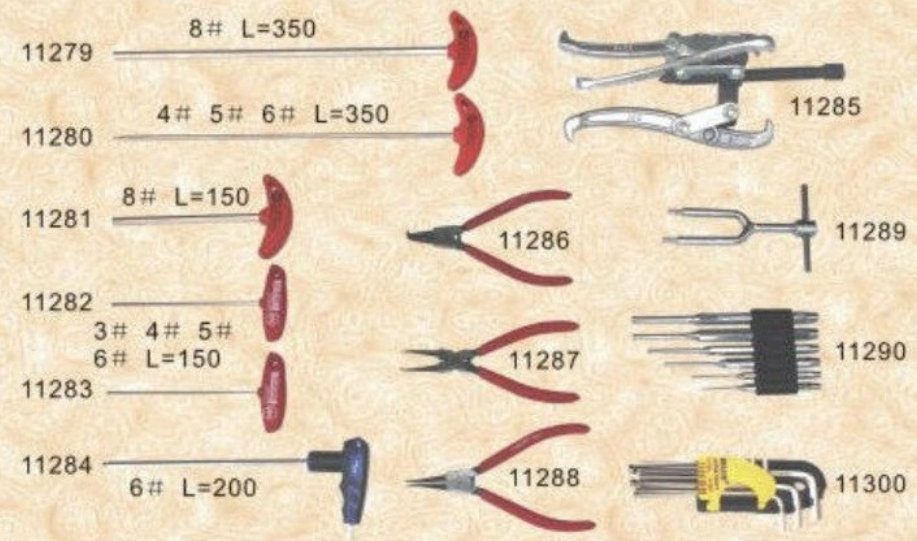

HB-117

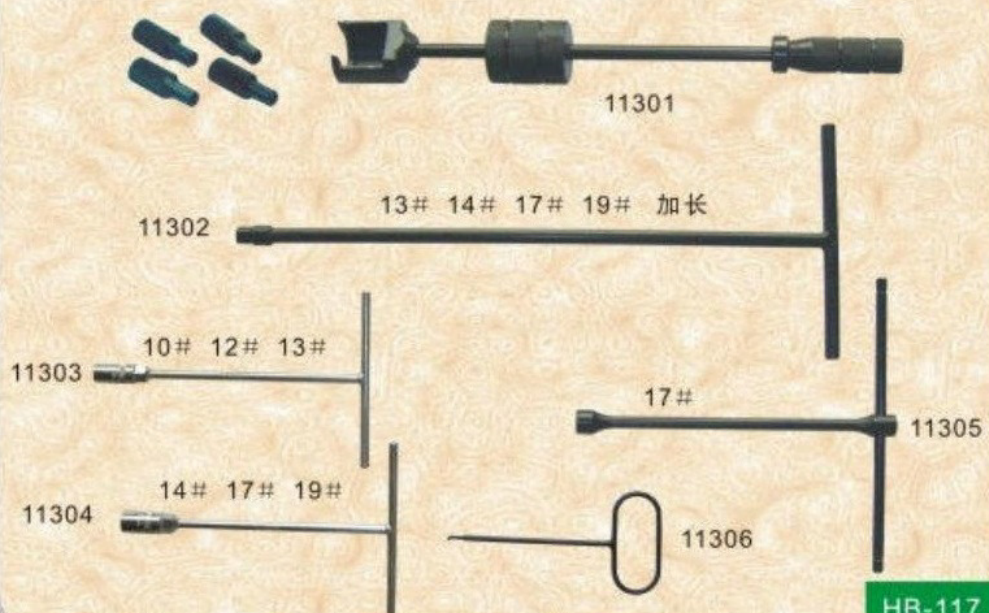

HB-118

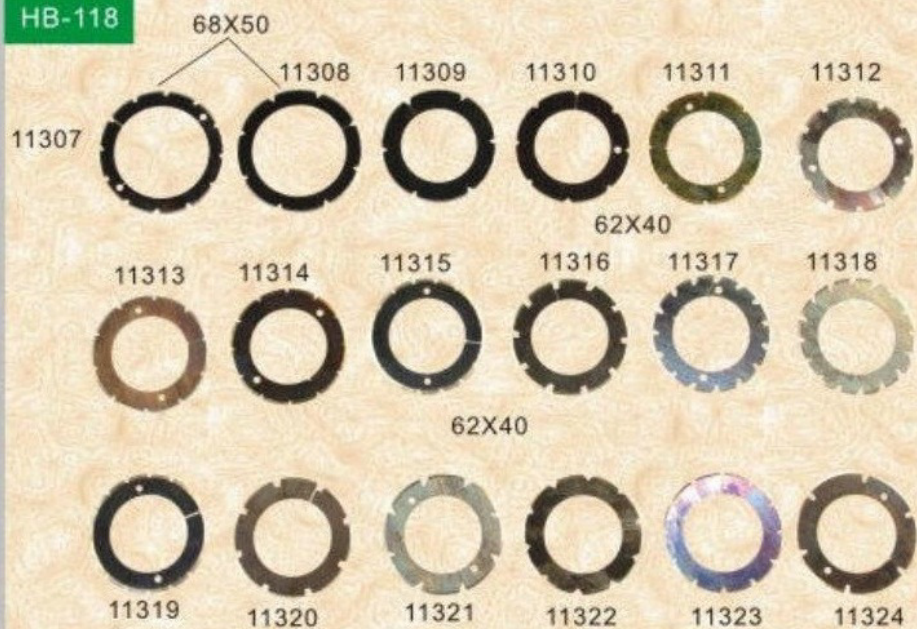

HB-119

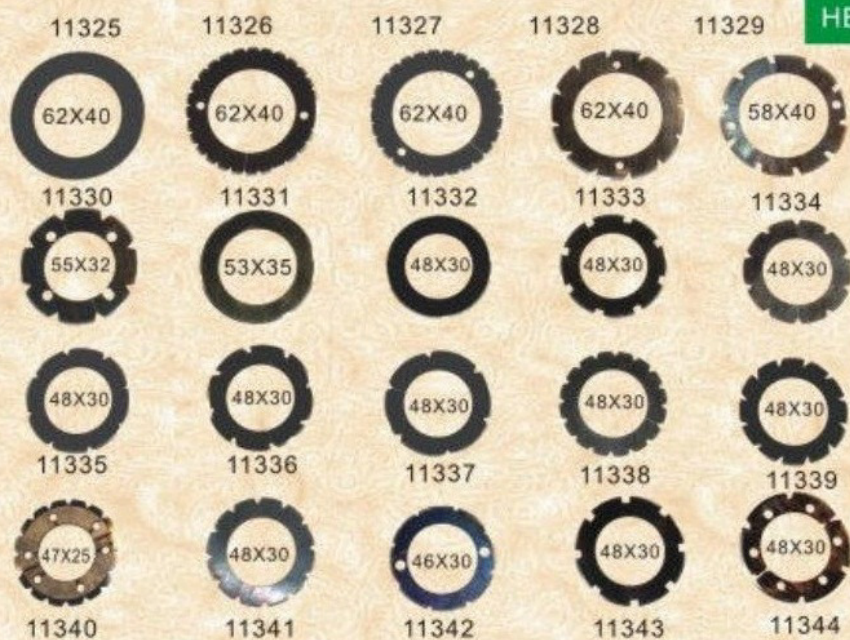

HB-120

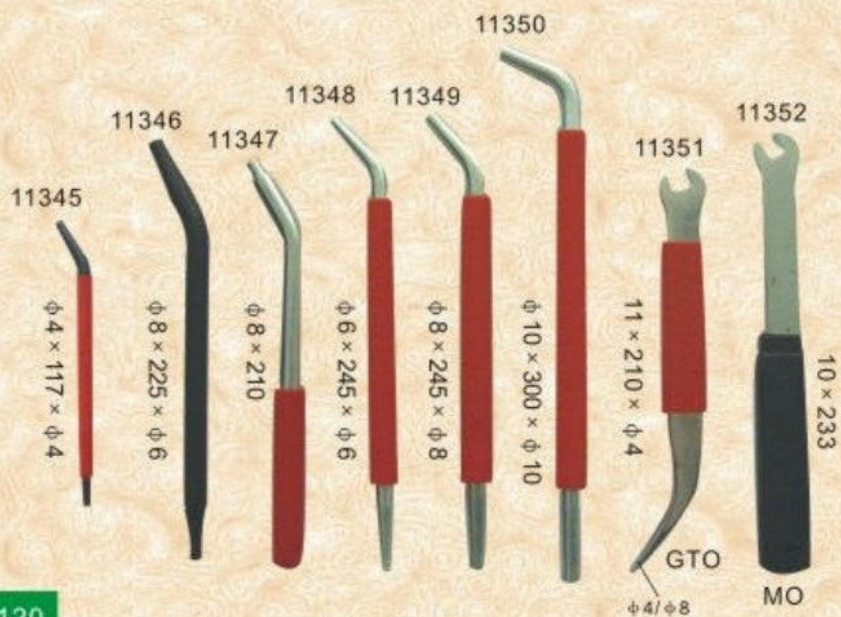

$\phi=4/5/6/8/10/12$
L=48-100MM 锥肖

$\phi=3/4/5/6/8/10/12/14$
L=40-150MM 锥肖

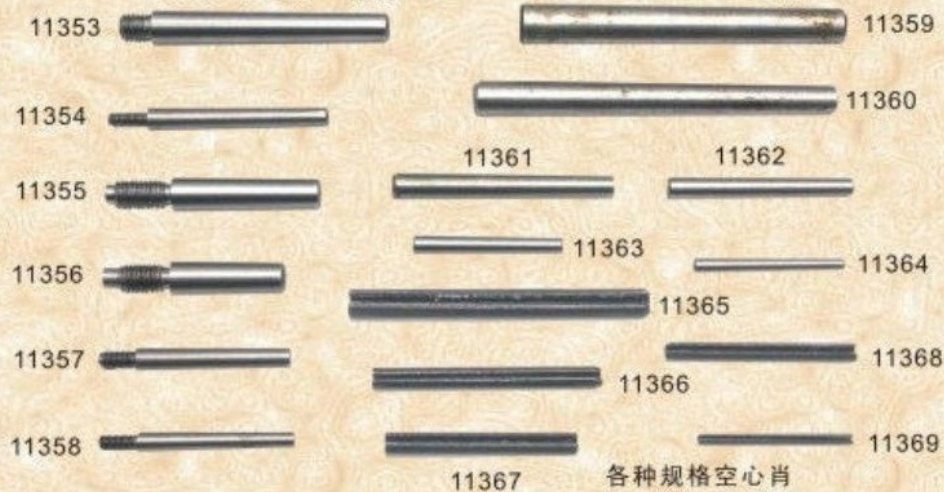

HB-121

HB-122



HB-123



HB-124



HB-125



HB-126

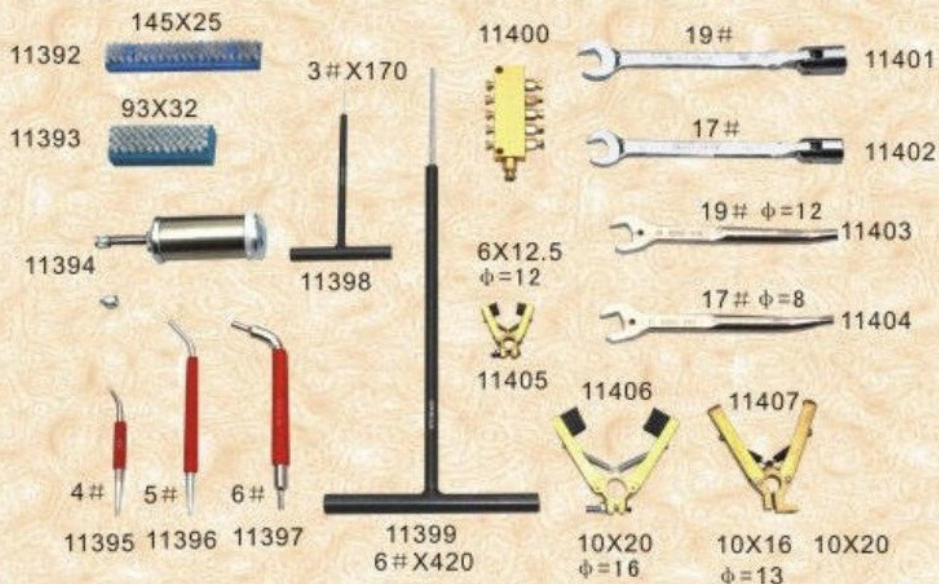

HB-127

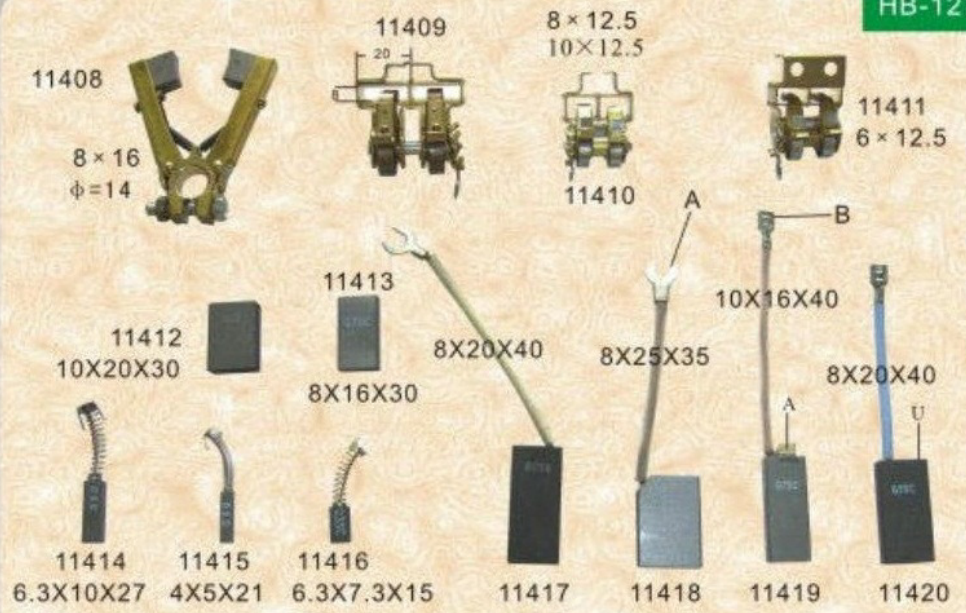

HB-128

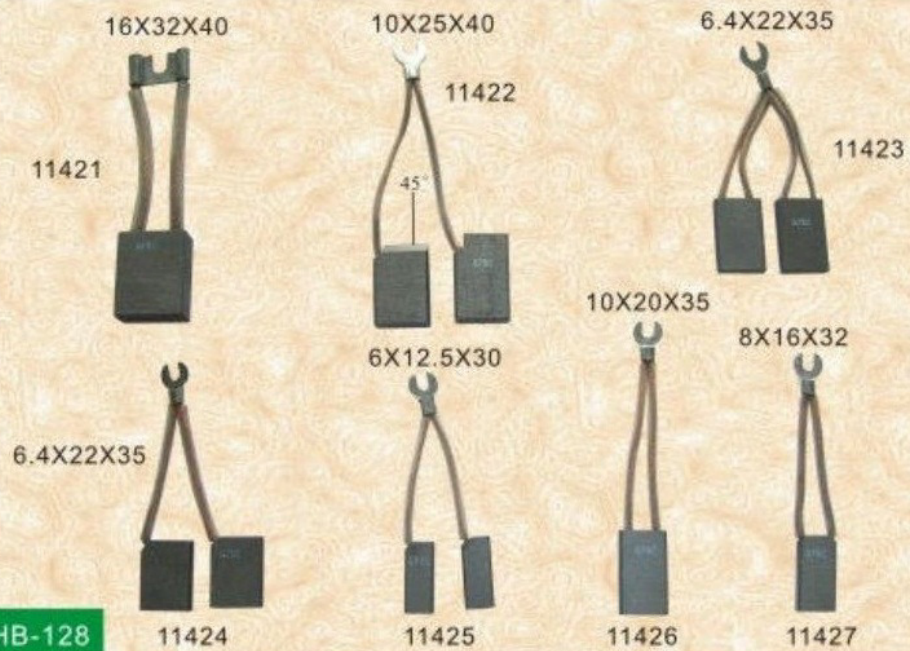

厚(T)X宽(W)X高(H)mm	厚(T)X宽(W)X高(H)mm
4X5X21	8X12.5X30
4X5X15	8X16X30
5X7X15	8X20X35
6X8X15	8X25X35
6X10X15	10X12.5X35
6X8X27	10X20X35
6.3X7.3X15	10X25X35
6.3X10X27	10X22X35
6X10X30	10X16X35
6X12.5X30	12.5X20X35
6X16X30	12.5X25X35
6.4X20X30	12.5X32X35
6.4X22X30	15X30X40
7X20X30	16X25X40
7X22X30	16X20X40
7X24X30	16X35X40
7X15X30	16X32.5X40
8X10X30	

带弹簧
碳刷

HB-129



HB-130



HB-131



HB-132



HB-133

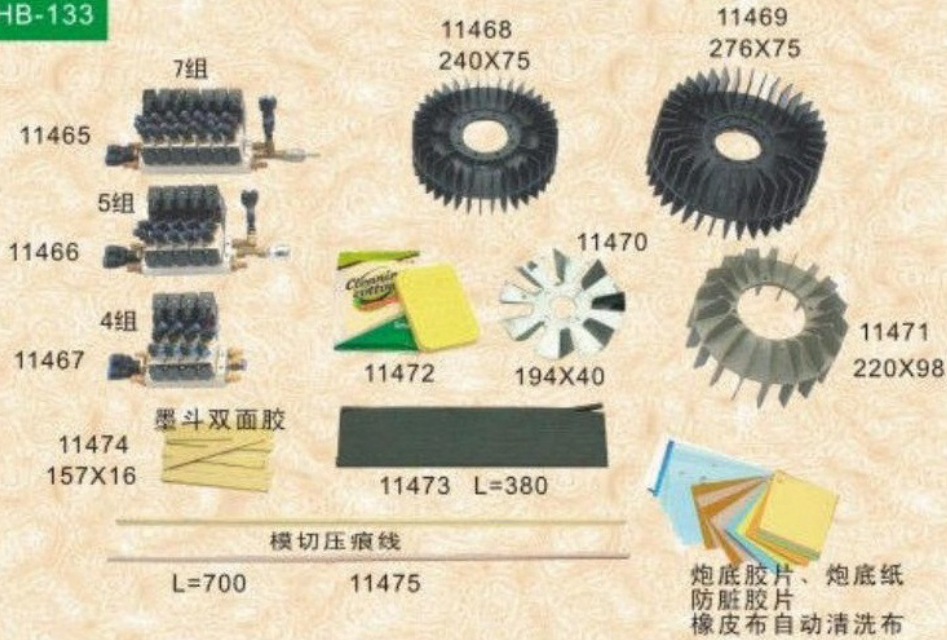

HB-134

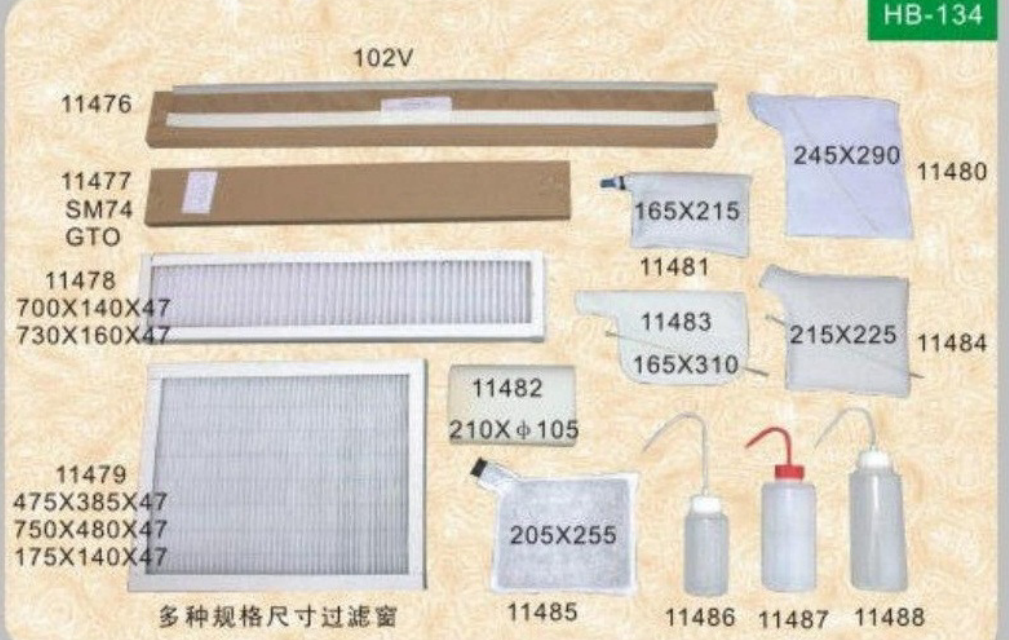

见表格

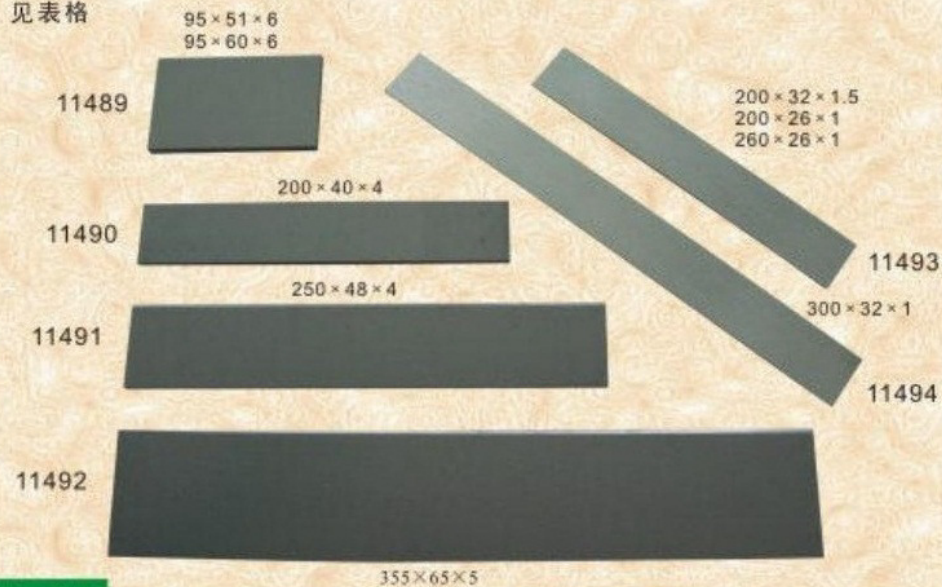

HB-135

长(L)X宽(W)X厚(T)mm	长(L)X宽(W)X厚(T)mm	长(L)X宽(W)X厚(T)mm
170X30X4	170X35X5	190X38X5
170X35X4	200X30X5	150X58X5
170X40X4	150X50X5	370X40X5
170X45X4	200X35X5	95X59X6
200X30X4	355X65X5	150X58X6
200X35X4	100X53X5	147X52X6
200X40X4	230X42X5	150X55X6
250X40X4	250X35X5	162X52X6
250X45X4	250X40X5	230X47X6
250X48X4	170X40X5	95X51X6
250X35X4	204X36X5	180X65X6
230X35X4	230X45X5	150X50X6
265X48X4	230X47X5	162X50X7
230X42X4	260X40X5	147X58X7
150X50X4	215X52X5	
265X40X4	260X52X5	

各种规格的碳片

HB-136

1.2×25×30M
1.5×25×30M
1×28×30M
1.2×28×30M
1.5×28×30M
1×20×30M
1×25×30M



11495

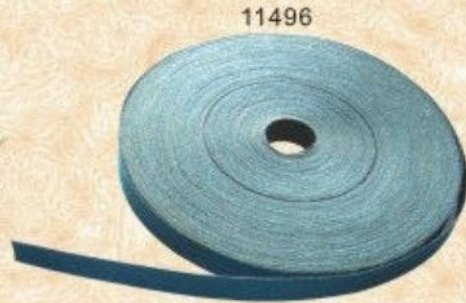

11496

0.8×25×30-100M
0.8×28×30-100M
0.8×20×30-100M
1×28×30-100M
1×30×30-100M



11497



11498



11499

HB-137

11500A



GLP 500
润滑油脂

11500B



链条油



11502

11501



6片/包

40#
60#

四开/对开/全张超级蓝网布



11503
330胶水



海绵条

11504

11505



70mm×25m
墨斗保护胶片

11506



H=145 d=92

11507



H=204 D=69 102V
H=195 D=69 SM74

中、英文版国际色标

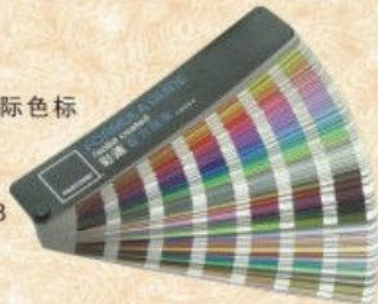

11508



11509

国产、进口水泡

HB-138

11510



链条油

H=128 D=50



11514

H=248 D=68



11515

H=125 D=50



11516

H=170 D=46



11517

L=1325X55



11513

H=86 D=53



11518

H=160 D=50



11519

11512



11511

L=960X60

11520



H=41 D=58

11521



H=130 D=38

HB-139

HB-140



HB-141

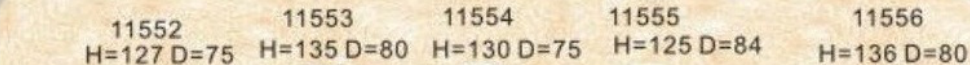

HB-142



HB-143

HB-144

T=0.3-3MM

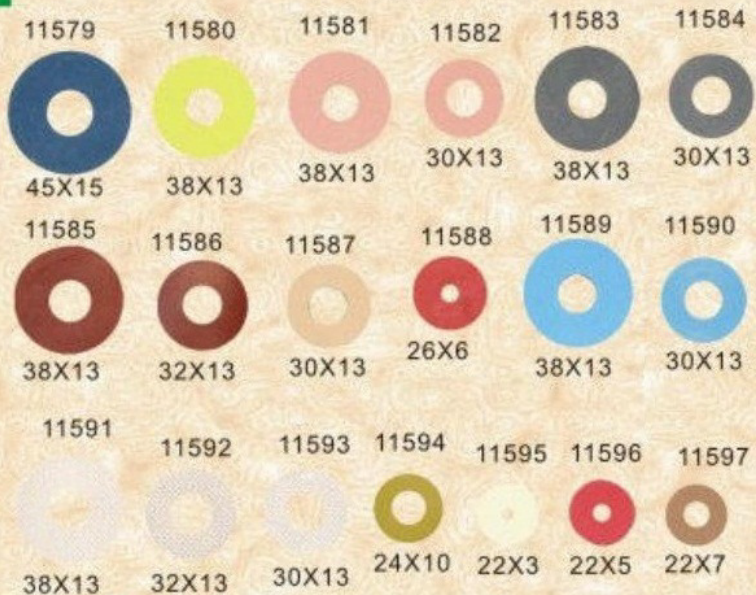

HB-145



HB-146

日本金牌水绒套及多种规格国产纯棉、化纤水绒套



针数	织机口径	适用胶印机 辊筒口径mm	针数	织机口径	适用胶印机 辊筒口径mm
44#	44	25-30	108#	89	61-63
52#	51	35-40	116#	95	68-70
64#	70	40-45	124#	102	74-77
76#	76	45-50	132#	108	85-88
84#	82	50-55	140#	114	90-93
96#	89	57-60	148#	120	96-100

HB-147

HB-148



HB-149



HB-150



HB-151



HB-152



HB-153



HB-154



HB-155

HB-156

11699 180#白砂纸 10米/卷 20米/卷
320#白砂纸 W=1230 W=1150

11700
过滤绵



11701



A



11702



11704



11705 喷粉



11706 红油



11703



小号四色墨铲

罗兰粉箱用

HB-157

11707



外径25MM

11708



外径25MM

11709



外径18MM



11710

11711



MO、PZ4650色标

11712



11716



外径22MM

11717



外径20MM

11718



外径17MM

11719



11713



11714



11715

11720



11721



外径13MM

11722



H=30MM
W=13MM

11723



H=15MM
W=14MM

11724



25X8
小森

11725



10z
胶齿轮

HB-158

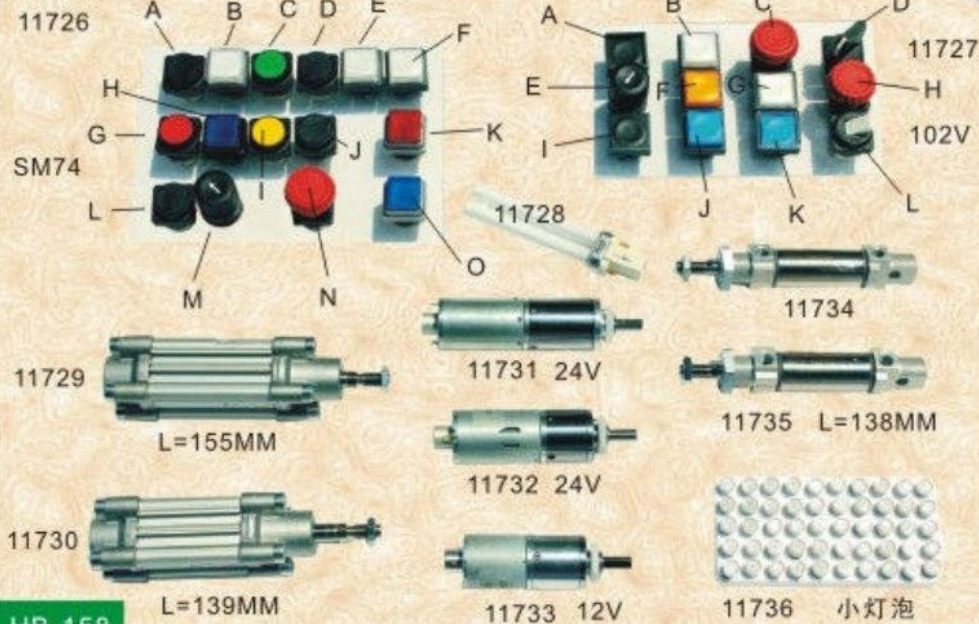

HB-158

11737



11738



11739



11740



11741



11742



11743



11744



11747



11748

11745



11746



11749



11751

11752



11753



11754



11755



11756

HB-159

HB-160



HB-161



HB-162

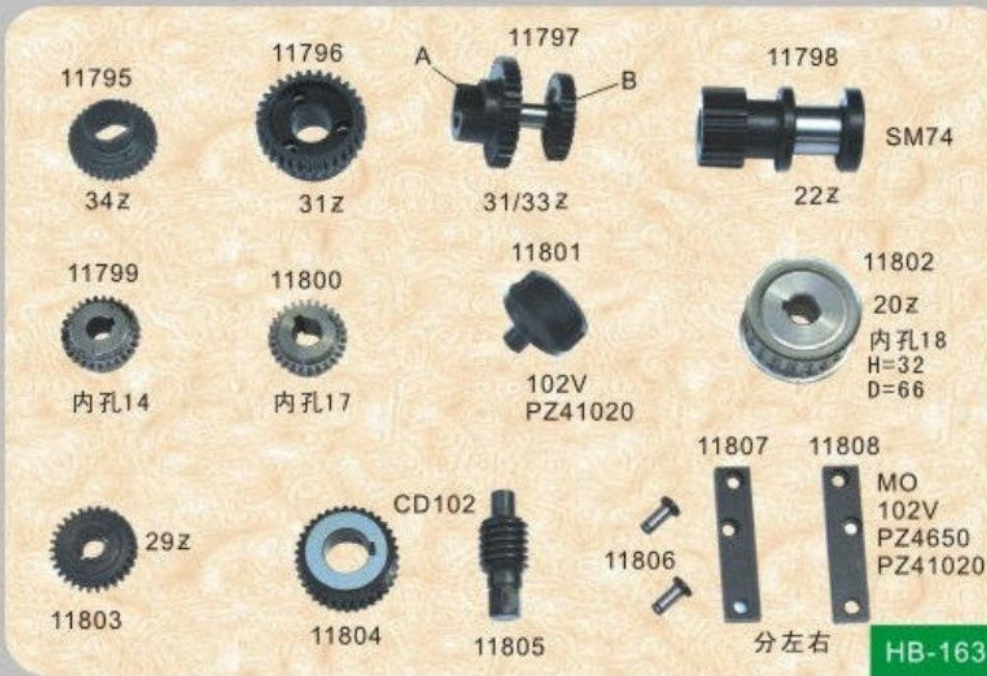

HB-163

HB-164



HB-165



HB-166

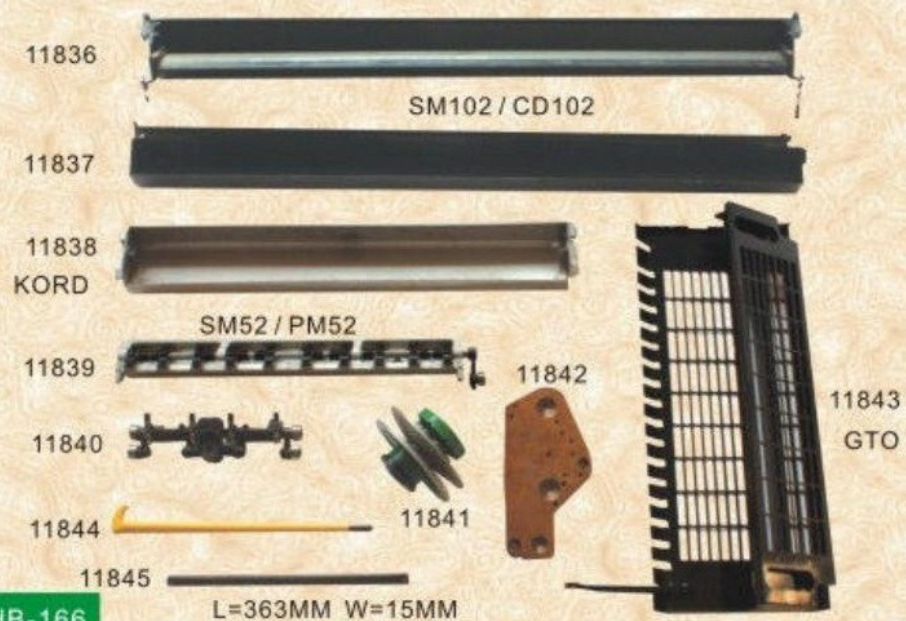

HB-167

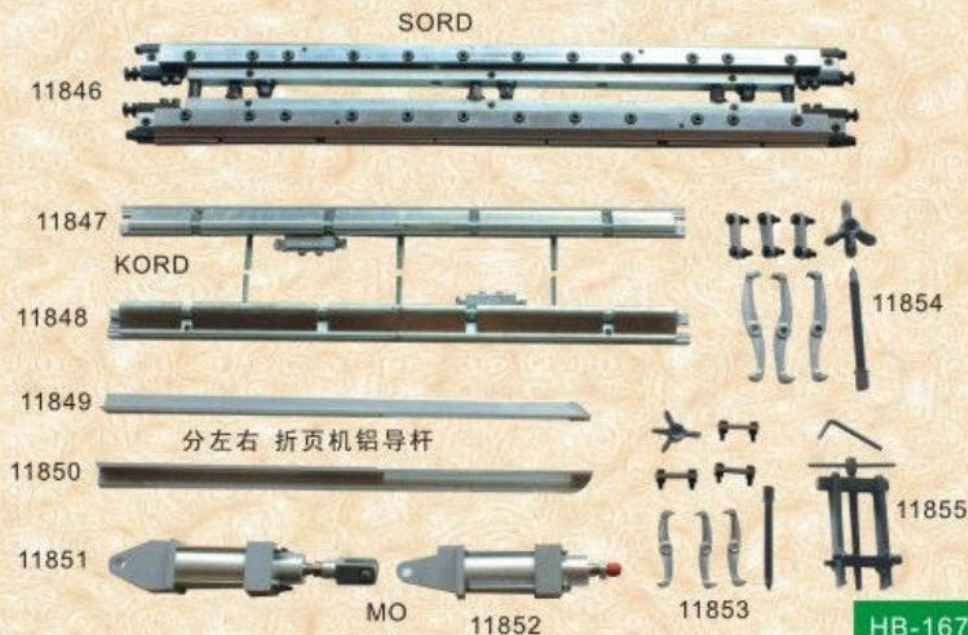

HB-168

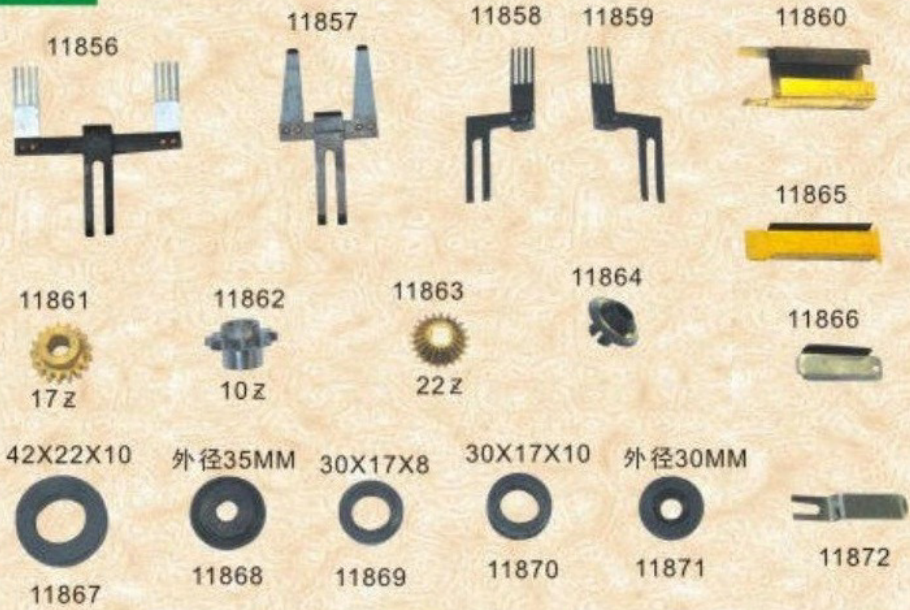

HB-169



HB-170



HB-171



HB-172



HB-173



HB-174



HB-175

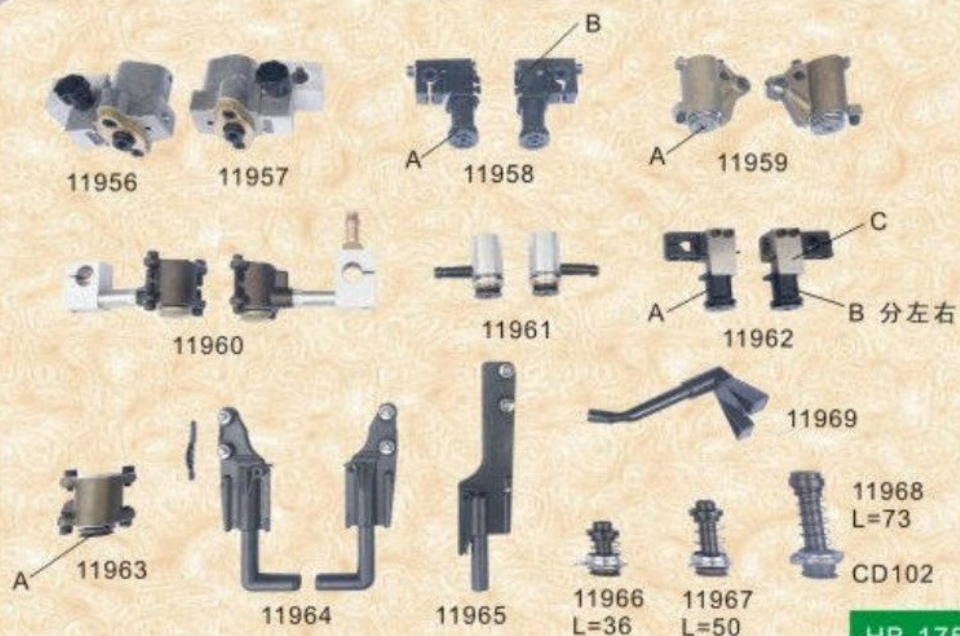

HB-176

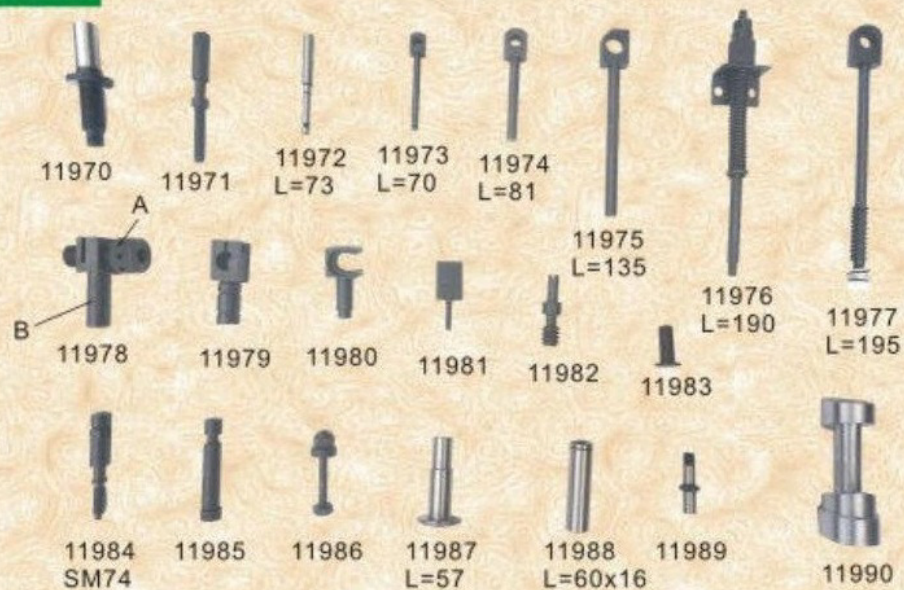

HB-177

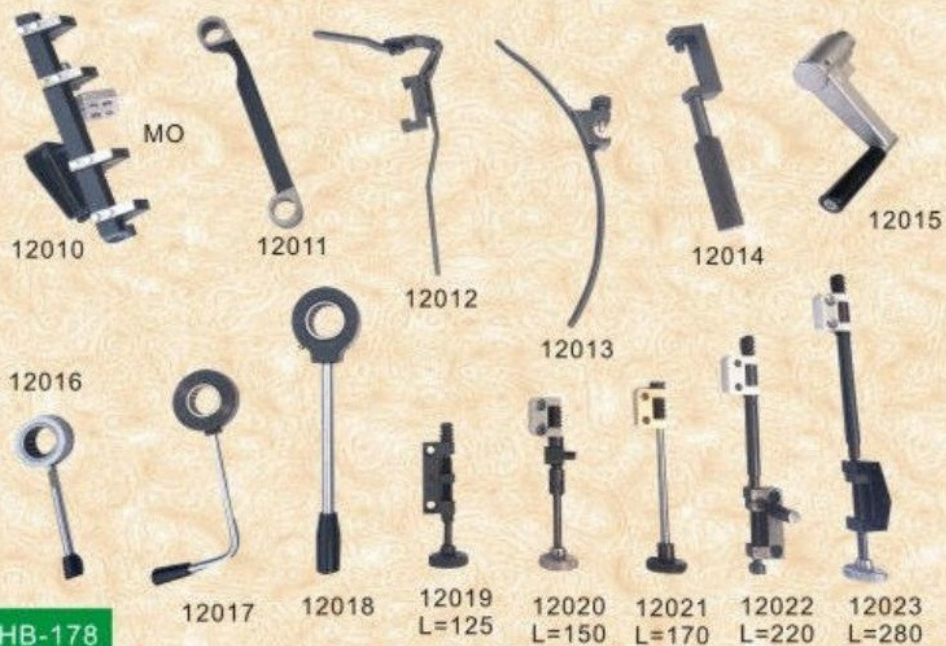
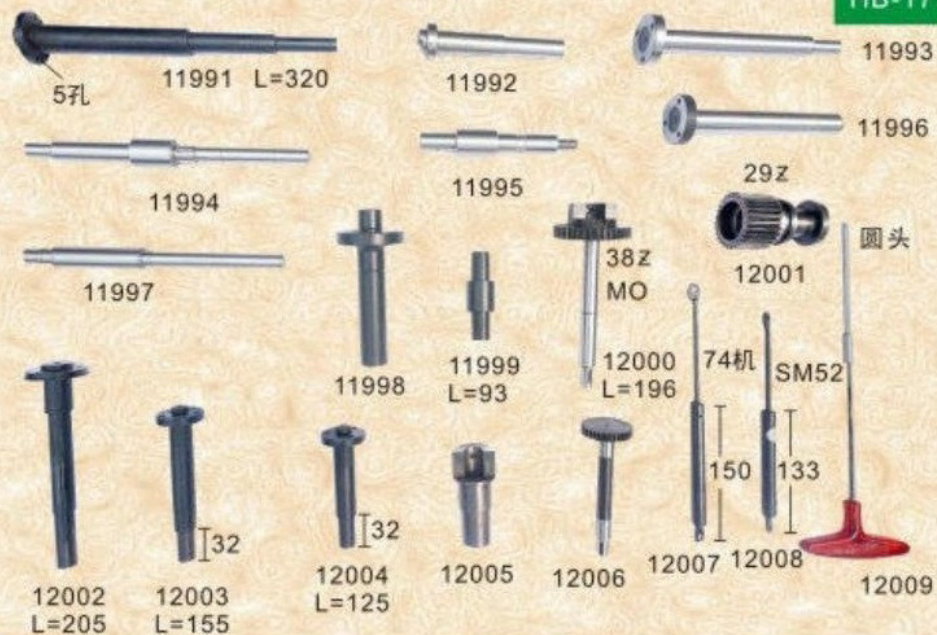

HB-178

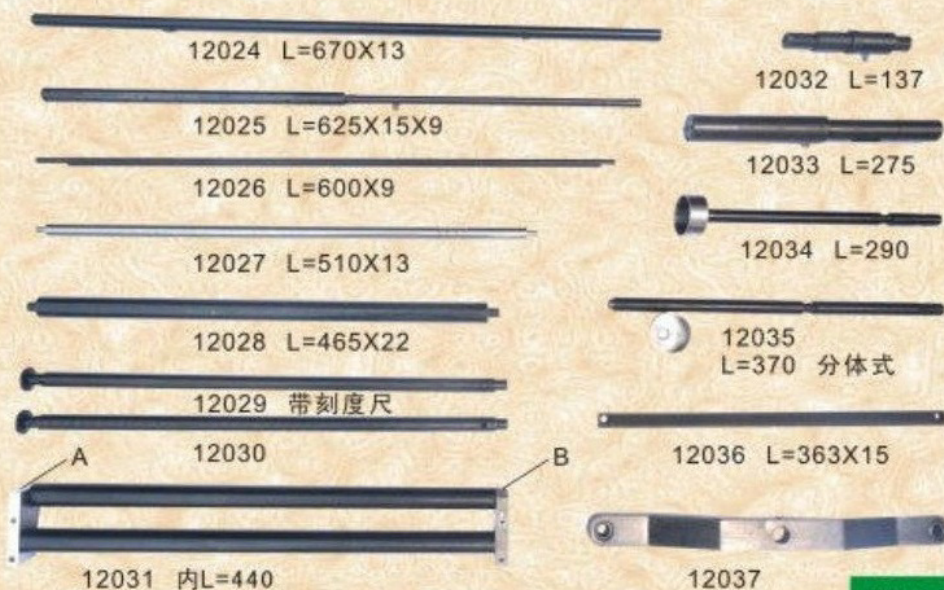

HB-179

HB-180



HB-181

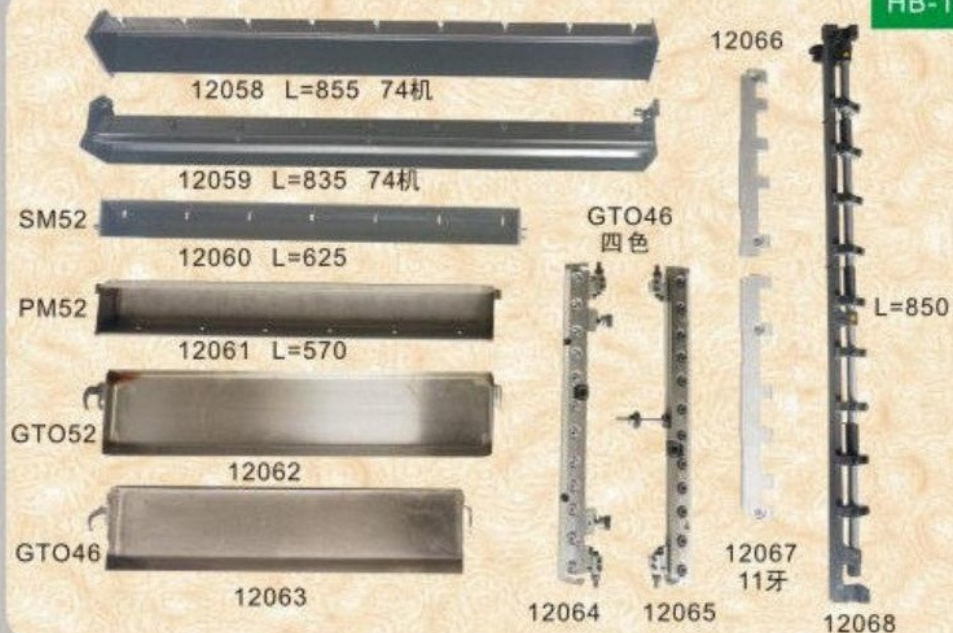

HB-182



HB-183

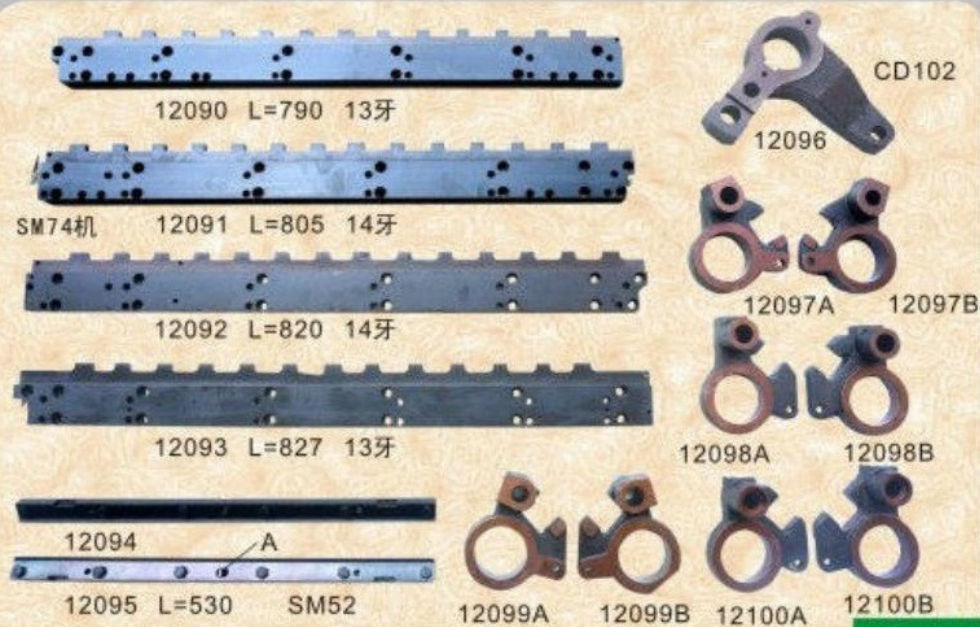

HB-184

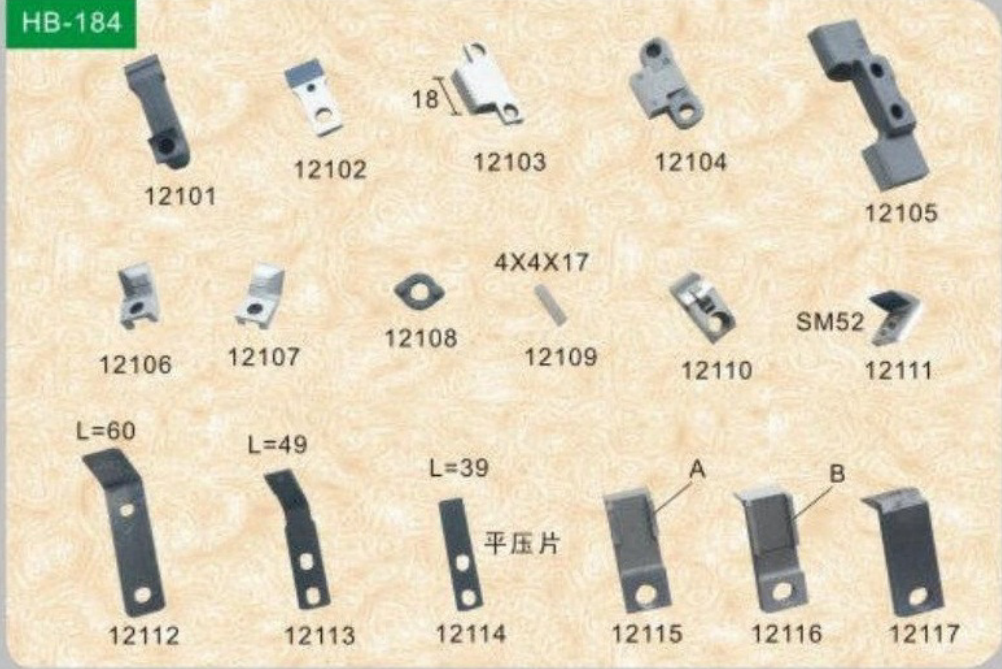

HB-185



HB-186

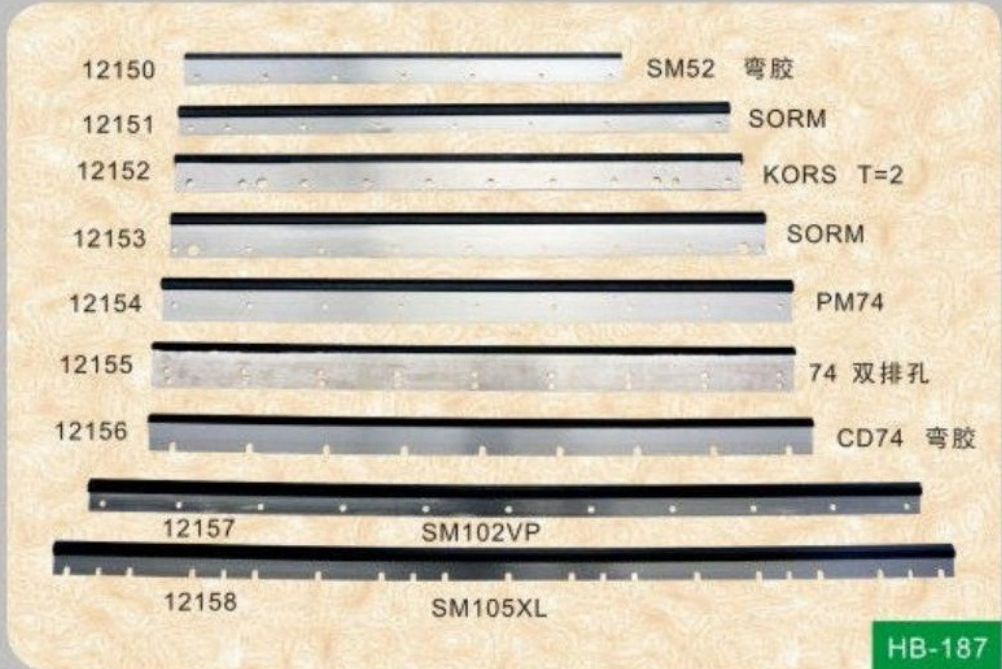

HB-187

HB-188



HB-189

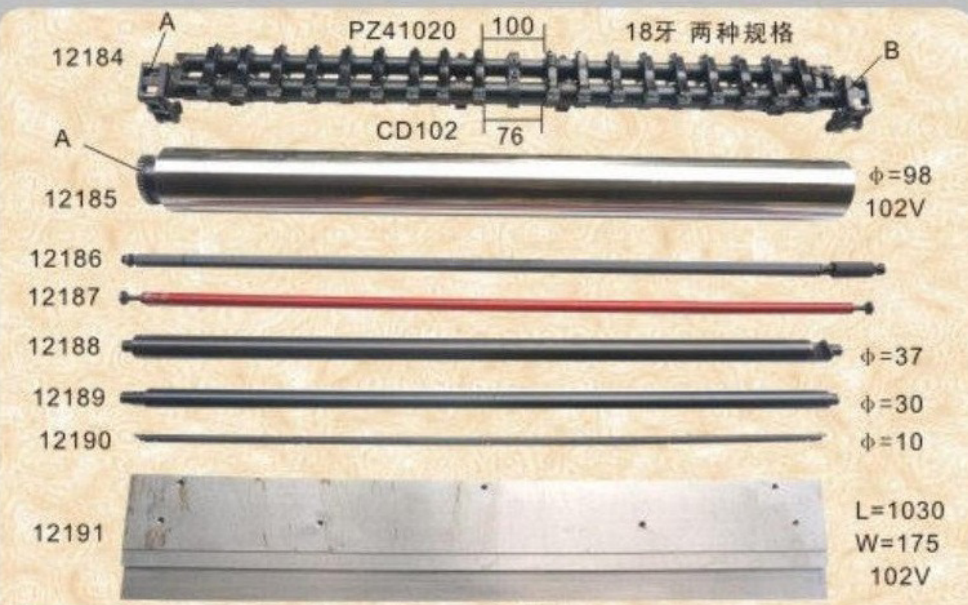

HB-190

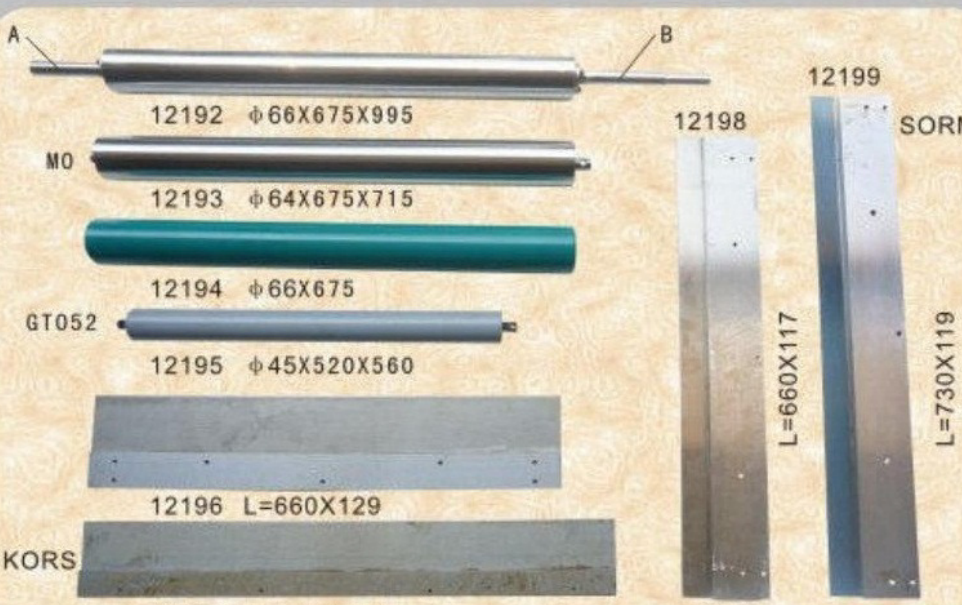

HB-191

HB-192



HB-193



HB-194



HB-195

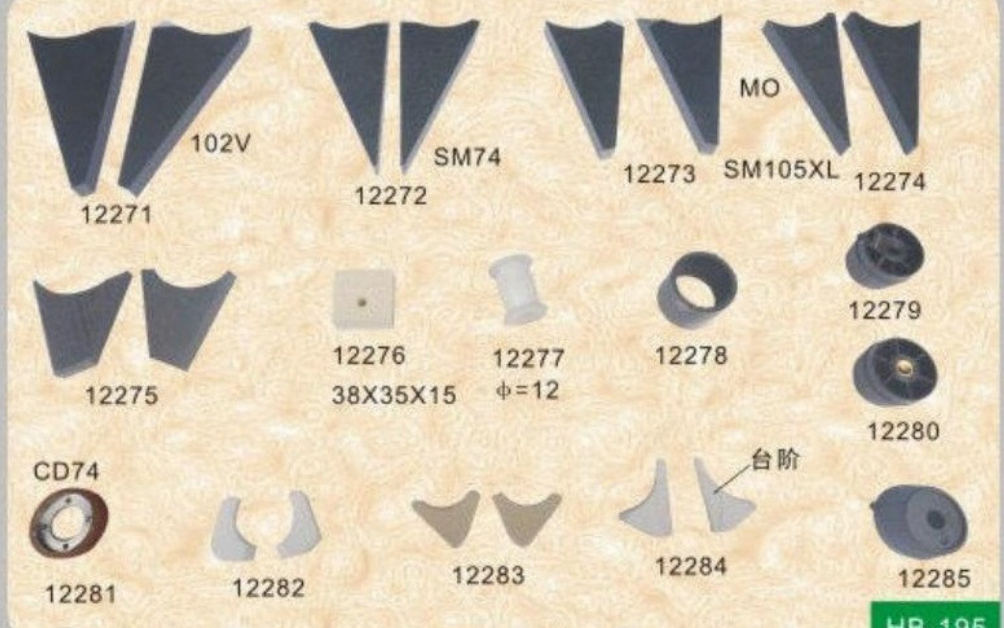

HB-196



HB-197



HB-198



HB-199



HB-199

HB-200



12365
45X55



12366
50X60



12367
50X60



12368
55X65



12369
45X55
T=42



12370
45X55
T=32



12371



12372

HB-201



12373
45X56
T=43



12374
45X56
T=32



12375
L=86X30X30



12376



12377
L=70



12378
L=70X19X19



12379
L=70X19X19



12380
 $\phi=4$
 $\phi=6$



12381



12382



12383
多种规格



12384



12385



12386
D=102



12387
12388



12389

HB-202



12390
L=175



12391
L=155



12392
L=180



12393
L=120



12394
L=96X28X28



12395
L=90X19X19



12396
L=100



12397
L=136



12398



32X40

12399

HB-203

HB-204



HB-205

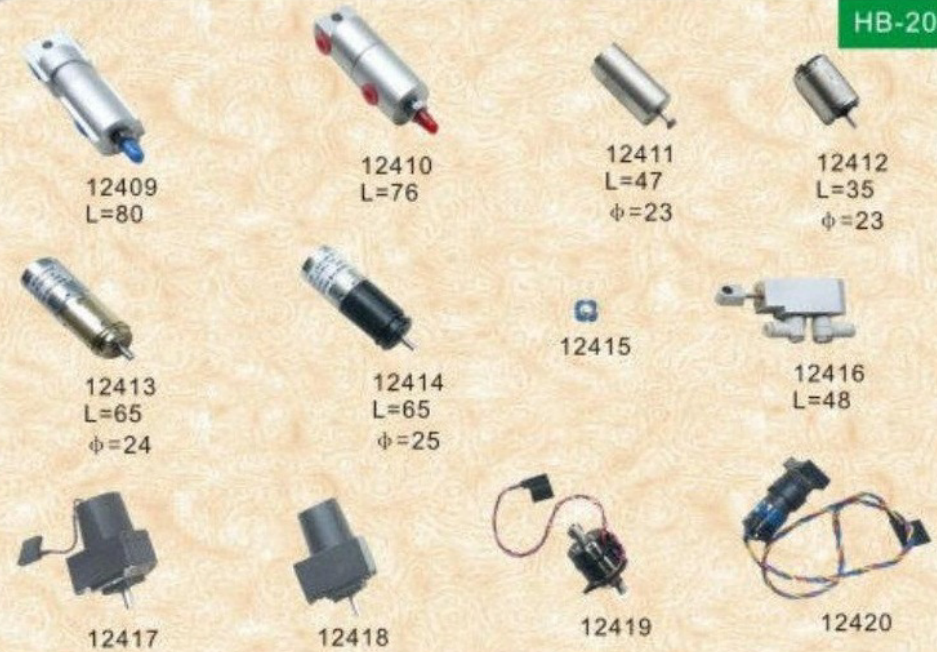

HB-206



HB-207

HB-208



HB-209



HB-210

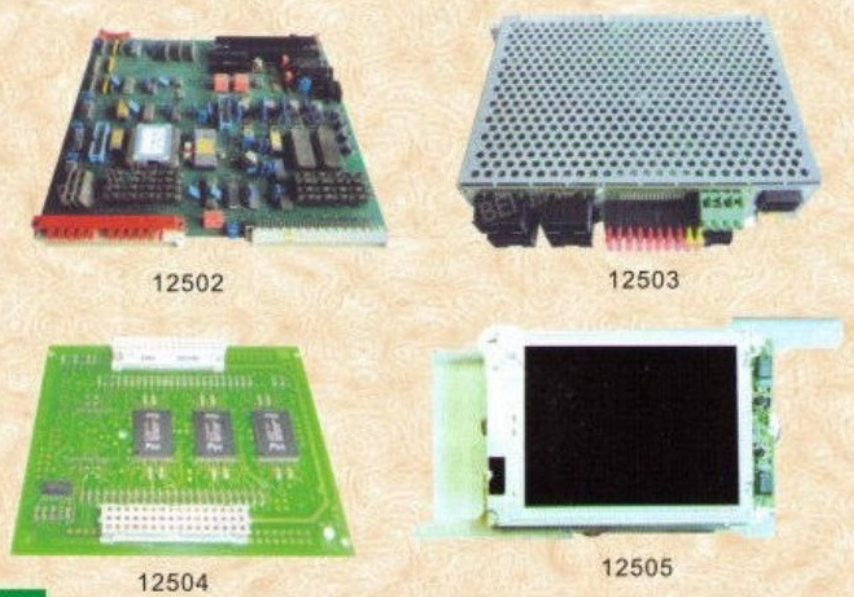

HB-211

